

TECH TECH CONTROLLERS

USER MANUAL

EU-402N PWM

EN



www.tech-controllers.com

TABLE OF CONTENTS

I.	Safety.....	3
II.	Use	4
III.	Principle of operation.....	4
IV.	User menu	5
1.	Home page	5
2.	Main menu – block diagram.....	6
2.1.	Operation mode	6
2.2.	Clock	7
2.3.	Date	8
2.4.	Ethernet module.....	8
2.5.	GSM module	8
2.6.	Statistics.....	8
2.7.	Backlight	9
2.8.	Display contrast	9
2.9.	Language.....	9
2.10.	Information.....	9
2.11.	Factory settings	9
V.	Service menu	9
3.	Service menu – block diagram.....	10
3.1.	Schemat instalacji	11
3.2.	Accumulation tank.....	18
3.3.	Solar collector	20
3.4.	Heat receiver	20
3.5.	Pumps	21
3.6.	Peripherals.....	23
3.7.	Energy counting	25
3.8.	Options	25
3.9.	Alarm sound.....	26
3.10.	Factory settings	26
3.11.	Edit service code.....	26
VI.	Protections	27
VII.	Software update.....	27
VIII.	Technical data	28
IX.	Installation.....	28

I. SAFETY

Before using the device for the first time the user should read the following regulations carefully. Not obeying the rules included in this manual may lead to personal injuries or controller damage. The user's manual should be stored in a safe place for further reference. In order to avoid accidents and errors it should be ensured that every person using the device has familiarized themselves with the principle of operation as well as security functions of the controller. If the device is to be sold or put in a different place, make sure that the user's manual is there with the device so that any potential user has access to essential information about the device.

The manufacturer does not accept responsibility for any injuries or damage resulting from negligence; therefore, users are obliged to take the necessary safety measures listed in this manual to protect their lives and property.



WARNING

- **High voltage!** Make sure the regulator is disconnected from the mains before performing any activities involving the power supply (plugging cables, installing the device etc.).
- The device should be installed by a qualified electrician.
- Before starting the controller, the user should measure earthing resistance of the electric motors as well as the insulation resistance of the cables.
- The regulator should not be operated by children.



NOTE

- The device may be damaged if struck by a lightning. Make sure the plug is disconnected from the power supply during storm.
- Any use other than specified by the manufacturer is forbidden.
- Before and during the heating season, the controller should be checked for condition of its cables. The user should also check if the controller is properly mounted and clean it if dusty or dirty.

Changes in the merchandise described in the manual may have been introduced subsequent to its completion on 16.03.2022. The manufacturer retains the right to introduce changes to the structure. The illustrations may include additional equipment. Print technology may result in differences in colours shown.



Care for the natural environment is our priority. Being aware of the fact that we manufacture electronic devices obligates us to dispose of used elements and electronic equipment in a manner which is safe for nature. As a result, the company has received a registry number assigned by the Main Inspector of Environmental Protection. The symbol of a crossed out rubbish bin on a product means that the product must not be thrown out to ordinary waste bins. By segregating waste intended for recycling, we help protect the natural environment. It is the user's responsibility to transfer waste electrical and electronic equipment to the selected collection point for recycling of waste generated from electronic and electrical equipment.

II. USE

EU-402N temperature regulator is intended for controlling solar collector systems in various configurations. The device controls the collector pumps (or both the pump and the valve) on the basis of solar batteries temperature and the accumulation tank temperature (two tanks). Optionally, it is possible to connect an additional device: circulating pump, electric heater or to send a signal to CH boiler in order to initialise the fire-up process. Controlling the circulating pump and sending a fire-up signal to the CH boiler may be done directly from the controller. An additional signal relay is necessary in order to control the heater. The controller offers PWM pump control option enabling the user to adjust its rotational speed.

III. PRINCIPLE OF OPERATION

Description of example control panel:

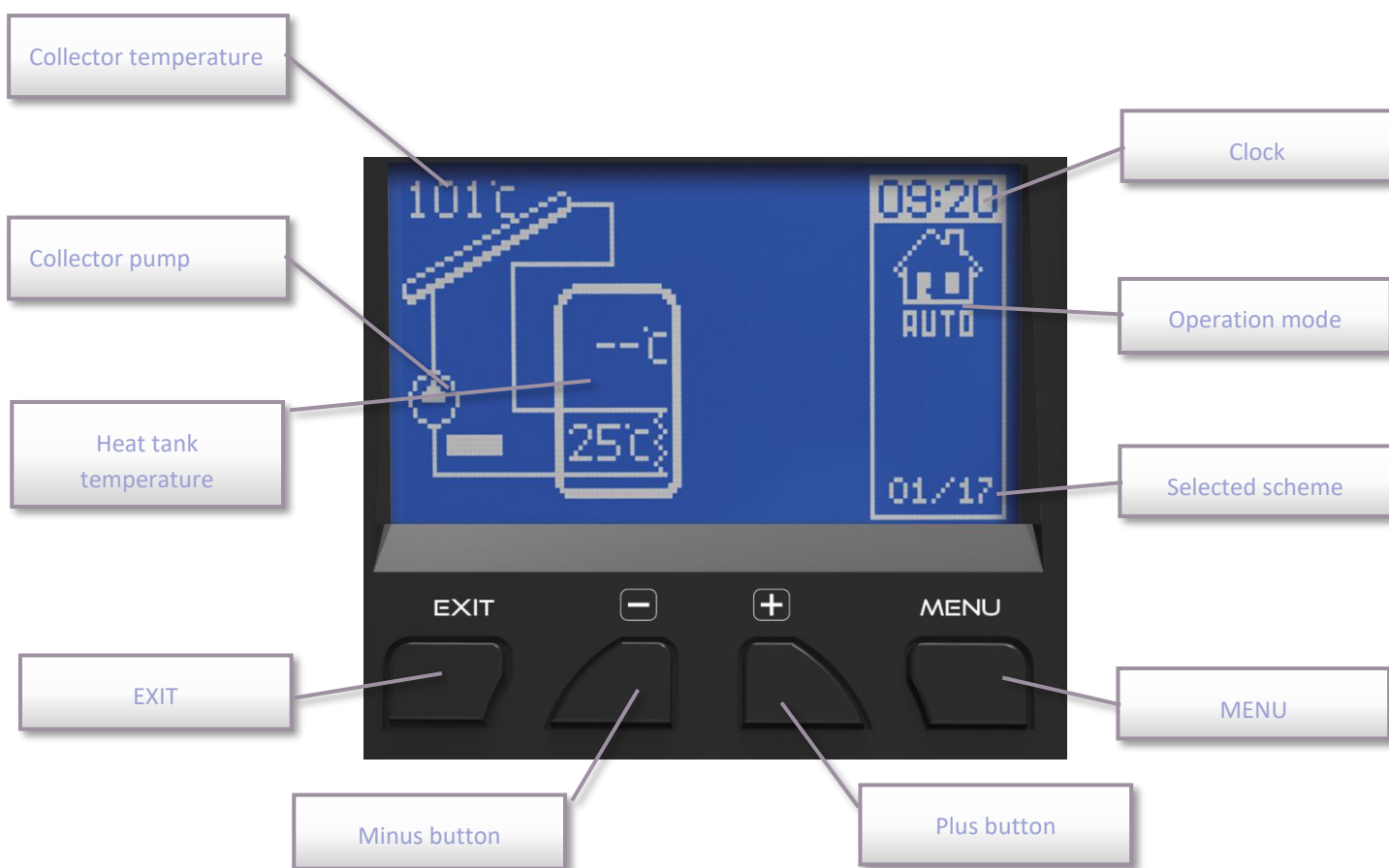

Use buttons to navigate through the menu. Press MENU to enter the menu or confirm the settings. Use PLUS and MINUS buttons to switch between menu options. Press MENU to confirm your choice. In order to return to the main screen view (or higher level menu), press EXIT button. Follow the procedure to adjust the settings.









IV. USER MENU

1. HOME PAGE

During standard operation of the controller, **graphic** display shows the main page. Apart from the selected scheme, the display also shows:

- operation mode (or type of alarm),
- current time,
- collector temperature,
- current temperature of the heat tank,
- temperature of all additional sensors depending on selected configuration.

On the right-hand side of the screen you may see the following icons:

Active operation mode icon		Icon of active additional device (peripherals)	
	Automatic operation mode		Circulating pump
	Collector defrosting mode		Pellet CH boiler fire-up (voltage-free signal)
	Holiday mode		Heater
	Collector overheating (alarm mode)		Anti - legionella
	Sensor damage (alarm mode)	1/17	Selected scheme

If one of the sensors is damaged, an additional icon will be flashing  in the place of the damaged sensor temperature. The icon indicates which sensor was disconnected or damaged.

Additionally, the pump icon will be displayed on the system scheme (if the pump is working/rotating) or/and the valve icon will appear (with an indication of current circulation direction).

2. MAIN MENU – BLOCK DIAGRAM

Due to multiple functions fulfilled by the controller, the menu is divided into Main menu and Service menu.

Main menu includes basic controller options such as operation mode, time and date settings, language version etc. It is illustrated by the following block diagram.

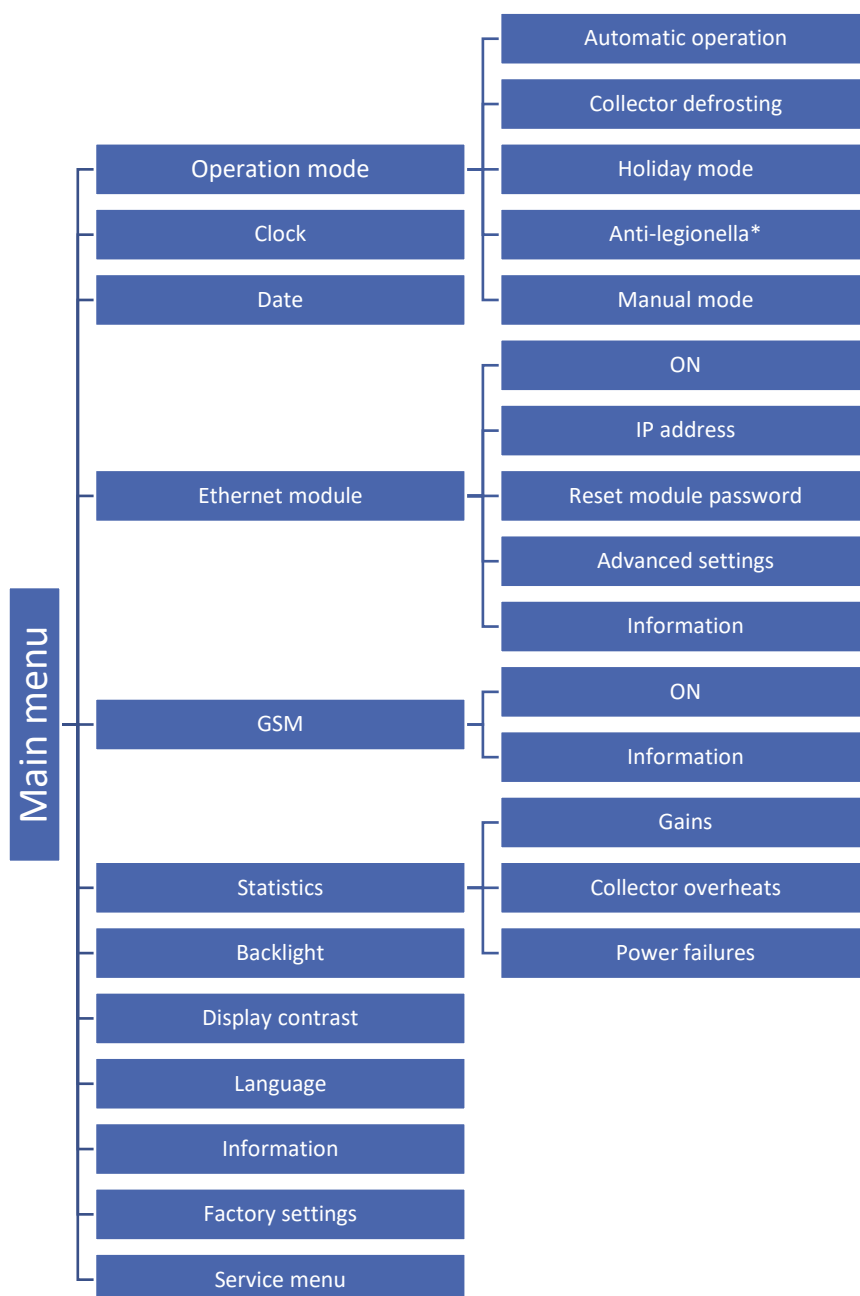

* The parameter is available only when an additional device (heater) is connected.

2.1. OPERATION MODE

This function enables the user to select the operation mode.

- **Automatic operation** - In automatic operation mode the pump is active when the minimum difference between collector and tank temperature is reached (the temperature difference at which the pump is enabled is defined as *Solar pump activation delta* in: SERVICE MENU>Pumps>Solar pump activation delta).

The pump remains active until the pre-set temperature is reached (to define the pre-set temperature go to SERVICE MENU>Accumulation tank>Pre-set temperature) or until the difference between collector and tank temperature reaches solar pump deactivation delta : SERVICE MENU>Pumps>Solar pump deactivation delta (in this case the pump will be activated again when the collector temperature exceeds the tank temperature by the value of solar pump activation delta). When the pump is disabled after the pre-set temperature is reached, it will be activated again when the temperature drops below the pre-set value by the tank hysteresis value (hysteresis may be defined in SERVICE MENU>Accumulation tank>Tank hysteresis).

- **Collector defrosting** - This function enables the user to activate the collector pump manually in order to cause the snow deposited on the solar collector to melt. After this function has been activated, the mode is active for a user-defined period of time. After this time automatic operation is resumed. To set the defrosting time go to: SERVICE MENU>Solar collector>Defrosting time. The function may be deactivated manually, to shorten its operation time, by selecting a different operation mode.

- **Holiday mode** - After this mode has been activated, the pump is active when one of the following conditions has been fulfilled:

Collector temperature reaches the overheating temperature value (SERVICE MENU> Solar collector> Overheating temperature) minus the value of *Holiday delta* parameter (SERVICE MENU>Solar collector>Holiday delta). When this condition is fulfilled, the pump is activated in order to cool the collector down. The pump is disabled when the temperature drops by 5°C.

Collector temperature is lower than the tank temperature – the pump is activated in order to cool the tank down. It remains active until the temperatures of the tank and the collector are equal.

- **Anti-legionella** - This function is active only when an additional device is connected (one of the *Peripherals* in the Service menu must be selected).

Thermal disinfection involves raising the temperature of water in the tank to the required disinfection temperature, read from the upper sensor of the tank (in the case of using an optional sensor, the user should make sure that it measures the temperature of water in the upper part of the tank, as it is the priority sensor for this function). Disinfection aims to eradicate Legionella pneumophila – bacteria which lower the cell-mediated immunity. The bacteria often multiplies in hot water reservoirs (optimum temperature: 35°C). After this function has been activated, the water tank is heated until the pre-defined temperature is reached (SERVICE MENU > Peripherals>Heater > Anti-legionella > Anti-legionella temperature). The temperature is maintained for the whole disinfection time (SERVICE MENU > Peripherals > Heater > Anti-legionella > Anti-legionella time). Next, the standard operation mode is restored.

Disinfection temperature needs to be reached within a pre-defined period of time from its activation (SERVICE MENU > Peripherals > Heater > Anti-legionella > Maximum anti-legionella time). Otherwise, the function will be automatically deactivated.

- **Manual mode** - This function enables the user to check the system devices manually (using MENU button) by switching ON/OFF:
 - the solar pump,
 - the second solar pump or the switching valve,
 - peripherals - additional devices (voltage-free contact e.g. for firing up the pellet boiler).

2.2. CLOCK

This function is used to set current time.

2.3. DATE

This submenu enables the user to set current date. Time and date settings are essential for energy counting function to operate correctly.

2.4. ETHERNET MODULE

Internet module is a device enabling the user remote control of the solar heating system via the Internet at emodul.eu. The user controls the status of all heating system devices on the home computer screen and the operation of each device is presented in the form of animation. Apart from the possibility to view the temperature of every sensor, the user can change the pre-set temperature of the tank etc. (depending on the type of installation scheme selected).

The installation process is intuitive. Connect the module and go to the main controller menu to activate the Internet module (Menu>>Ethernet module>>ON). Once Registration option has been selected, the device generates a code which must be entered on the website.



NOTE

This type of control is available only after purchasing and connecting an additional controlling module ST-505 which is not included in the standard controller set.



NOTE

The code is valid for 60 minutes. If the user fails to register on the website within this time, a new code must be generated. Internet module parameters such as IP address, IP mask, gate address etc. may be set manually or by selecting DHCP option.

2.5. GSM MODULE

GSM Module is an optional device which, cooperating with the controller, enables the user remote control of the CH boiler operation via mobile phone. The user is sent an SMS each time an alarm occurs. Moreover, after sending a certain text message, the user receives feedback on the current temperature of all the sensors.

ST-65 module may operate independently of the collector controller. It has two additional inputs with temperature sensors, one contact input to be used in any configuration (detecting closing/opening of contacts) and one controlled output (e.g. a possibility of connecting an additional contractor to control any electric circuit)

When any of the temperature sensors reaches the pre-set maximum or minimum temperature, the module automatically sends an SMS message with such information. A similar procedure is used in the case of opening or closing of the contact input, which may be used as a simple means of property protection.



NOTE

This type of control is available only after purchasing and connecting an additional controlling module ST-65 which is not included in the standard controller set.

2.6. STATISTICS

This submenu enables the user to monitor current operating status of the controller:

- Gains - This parameter enables the user to check how much energy was gained in different time periods: daily, weekly, monthly, annually and temporary.



NOTE

Statistics provide only approximate data to illustrate roughly the energy gain.

- **Collector overheats** - this submenu shows a list of collector overheats (instances of too high temperature detected by the collector sensor). The user may view:
 - Date of the overheat incident
 - Time
 - Duration
 - Reading from collector sensor
- **Power failure** - this submenu shows a list of power failures registered by the controller. The user may view:
 - Date
 - Time
 - Duration

2.7. BACKLIGHT

This parameter is used to adjust the screen brightness. The screen brightness changes after a few seconds of inactivity.

2.8. DISPLAY CONTRAST

This parameter is used to adjust the display contrast.

2.9. LANGUAGE

This option is used to select the language version of the controller menu.

2.10. INFORMATION

Once this option has been selected, the display shows the controller manufacturer's logo and current software version.

2.11. FACTORY SETTINGS

This function is used to restore factory settings saved previously in the service menu.

V. SERVICE MENU

To enter the service settings, select the SERVICE MENU option, then select the code 0112 using the plus and minus buttons and confirm by pressing the menu button. To return to the main view of the display (to leave the service menu), use the exit key by pressing several times or wait about 30 seconds (then the device will automatically exit the service mode).

3. SERVICE MENU – BLOCK DIAGRAM

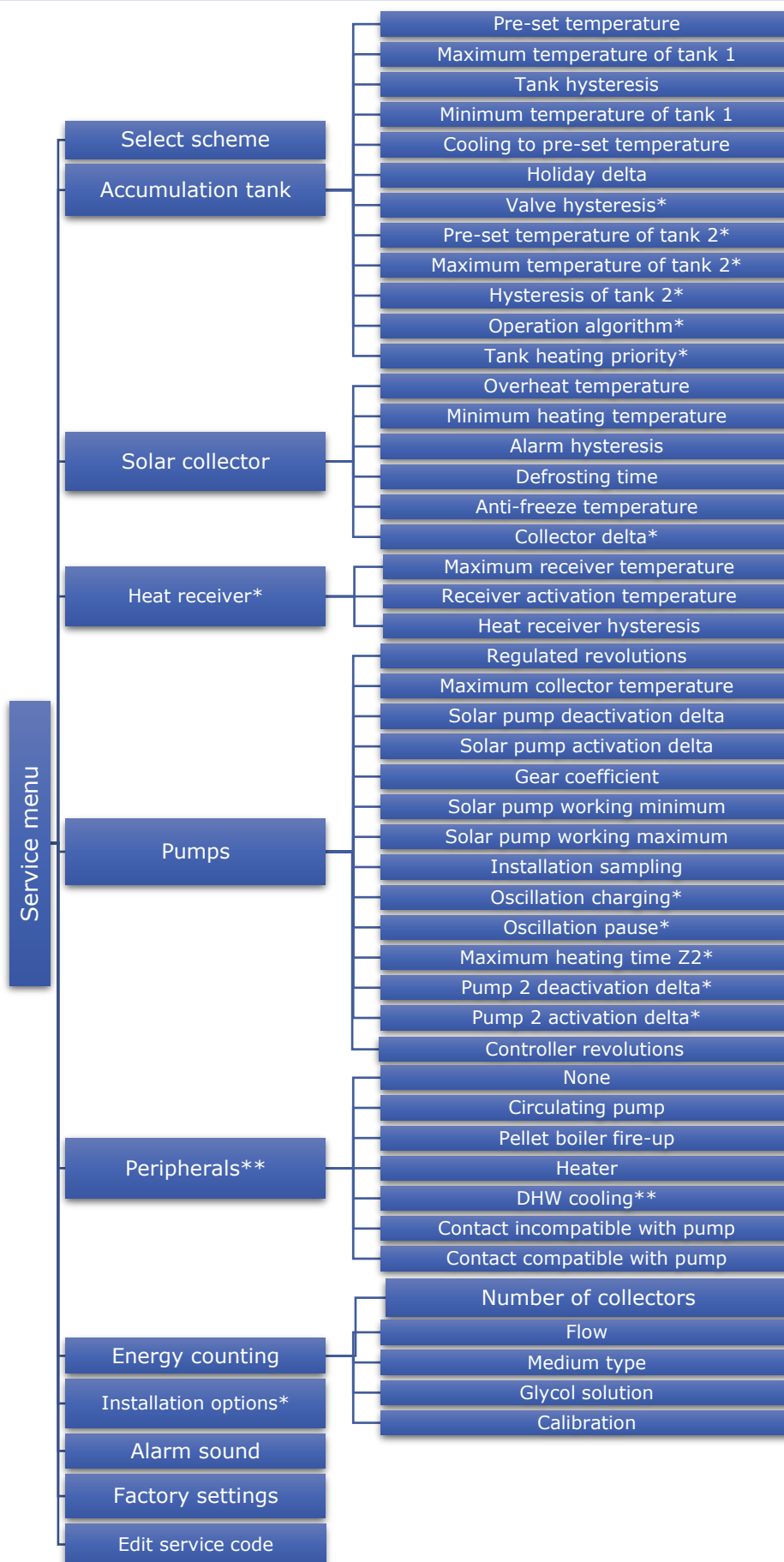

3.1. SCHEMAT INSTALACJI

To ensure effective operation of the solar heating system, it is necessary to select proper installation scheme (SERVICE MENU > INSTALLATION SCHEME) and configure additional options for the selected scheme.



NOTE

While selecting an installation scheme, in the place of the sensor temperature the screen displays the sensor number. Follow these numbers while connecting the sensors in proper places (order from left to right):

- (1) – collector sensor (PT1000),
- (2) – tank sensor (PT1000),
- (3) – additional sensor 1 (PT1000),
- (4) – additional sensor 2 (PT1000).

SCHEME 1/17 – BASIC

Installation 1/17 supports:

- collector pump,
- accumulation tank,
- one direction of collector positioning,
- additional peripherals.

Installation sensors:

- collector sensor,
- accumulation tank sensor.

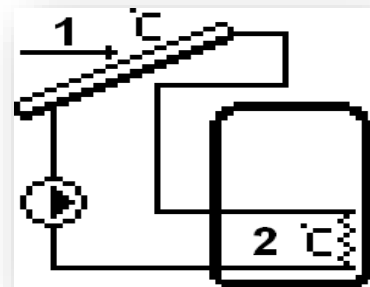

SCHEME 2/17 – ONE TANK – SEQUENCE

Installation 2/17 supports:

- collector pump,
- top-bottom switching valve,
- accumulation tank with lower and upper circuit
- one direction of collector positioning,
- additional peripherals.

Installation sensors:

- collector sensor,
- two sensors of the accumulation tank - upper one and lower one.

Additional parameters to be configured:

- valve hysteresis
- oscillation charging
- oscillation pause
- maximum heating time Z2

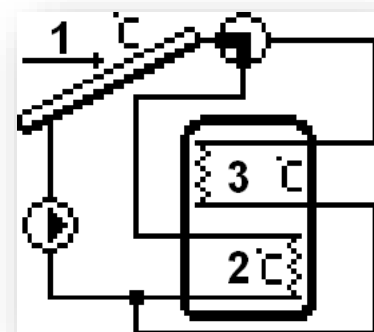

SCHEME 3/17 – TWO COLLECTORS, TWO PUMPS

Installation 3/17 supports:

- two collector pumps (the pumps operate independently in separate circuits),
- accumulation tank,
- two directions of collector positioning,
- additional peripherals.

Installation sensors:

- two collector sensors,
- accumulation tank sensor.

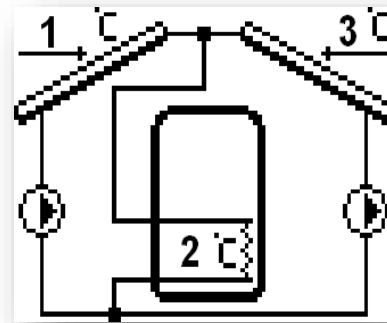

NOTE

Collector settings (SERVICE MENU>>SOLAR COLLECTOR) concern collectors positioned in both directions.

Additional parameters to be configured:

- Pump deactivation delta 2
- Pump activation delta 2

SCHEME 4/17 – TWO COLLECTORS, VALVE

Installation 4/17 supports:

- collector pump,
- collector switching valve
- accumulation tank,
- two directions of collector positioning,
- additional peripherals.

Installation sensors:

- two collector sensors,
- accumulation tank sensor.

Additional parameters to be configured:

- Collector delta

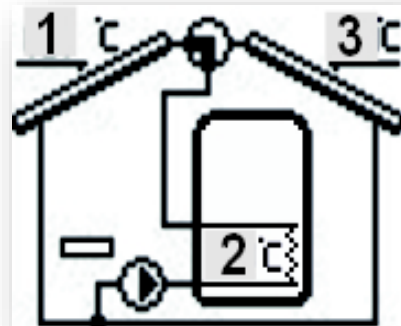

SCHEME 5/17 – CH BOILER HEATING

Installation 5/17 supports:

- collector pump,
- auxiliary pump – tank-boiler (*Pump 2*),
- accumulation tank with lower and upper circuit,
- one direction of collector positioning,
- additional peripherals (no possibility of cooling down with DHW pump)

Installation sensors:

- collector sensor,
- two sensors of accumulation tank - upper and lower one
- CH boiler temperature sensor.

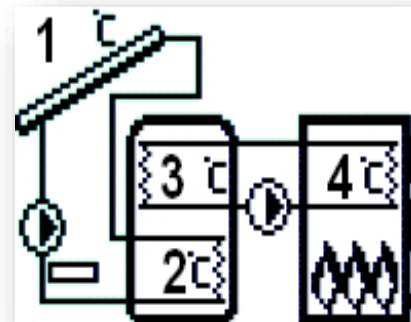

Additional parameters to be configured (additional submenu in service menu):

- Installation options: heating activation delta, from hour... to hour..., energy return, energy return threshold, energy return hysteresis, energy return solar pump.

SCHEME 6/17 – TWO TANKS, VALVE

Installation 6/17 supports:

- collector pump,
- tank switching valve,
- two accumulation tanks,
- one direction of collector positioning,
- additional peripherals.

Installation sensors:

- collector sensor,
- sensors of accumulation tanks.

Additional parameters to be configured:

- pre-set temperature of tank 2
- maximum temperature of tank 2
- tank 2 hysteresis
- oscillation charging
- oscillation pause
- maximum heating time Z2
- valve hysteresis

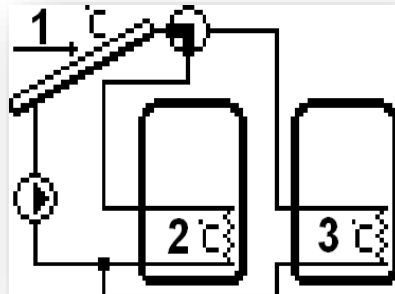

SCHEME 7/17 – TWO TANKS, TWO PUMPS

Installation 7/17 supports:

- two collector pumps,
- two accumulation tanks,
- one direction of collector positioning,
- additional peripherals.

Installation sensors:

- collector sensor,
- sensors of accumulation tanks.

Additional parameters to be configured:

- valve hysteresis
- pre-set temperature of tank 2
- maximum temperature of tank 2
- tank 2 hysteresis
- operation algorithm
- oscillation charging
- oscillation pause
- maximum heating time Z2
- pump 2 deactivation delta
- pump 2 activation delta

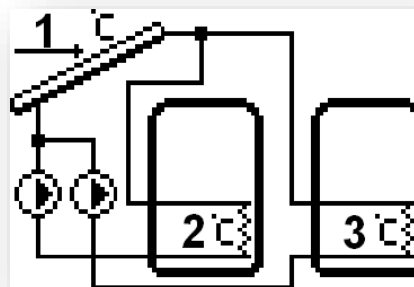

SCHEME 8/17 – TWO TANKS – SEQUENCE

Installation 8/17 supports:

- collector pump,
- tank 2 pump,
- tank 1 with lower and upper circuit
- tank 2,
- one direction of collector positioning,
- additional peripherals (no possibility of cooling with DHW pump)

Installation sensors:

- collector sensor,
- two sensors of accumulation tank - upper and lower one
- sensor of additional accumulation tank.

Additional parameters to be configured:

- Pre-set temperature of tank 2
- Maximum temperature of tank 2
- Tank hysteresis 2
- Operation algorithm
- Pump deactivation delta 2
- Pump activation delta 2

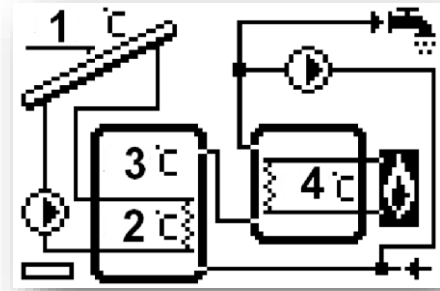

SCHEME 9/17 – HEAT EXCHANGER

Installation 9/17 supports:

- collector pump,
- valve switching between the tank and heat exchanger
- accumulation tank,
- heat exchanger (heat receiver),
- one direction of collector positioning,
- additional peripherals.

Installation sensors:

- collector sensor,
- accumulation tank sensor.
- heat exchanger sensor.

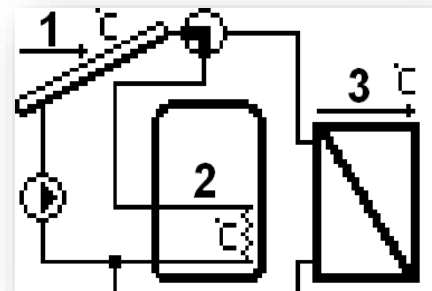

Apart from the accumulation tank, this system also includes a heat receiver (e.g. swimming pool or CH system) whose task is to emit the heat rather than accumulate it.

Additional parameters to be configured:

- valve hysteresis
- pre-set temperature of tank 2
- maximum temperature of tank 2
- tank 2 hysteresis
- oscillation charging
- oscillation pause
- maximum heating time Z2
- tank heating priority

SCHEME 10/17 – DUAL-FUNCTION BOILER

Installation 10/17 supports:

- collector pump,
- valve switching to a two-state heating boiler
- accumulation tank with lower and upper circuit,
- dual-function boiler (heating the tank output),
- one direction of collector positioning,
- additional peripherals.

Installation sensors:

- collector sensor,
- two sensors of accumulation tank - upper and lower one

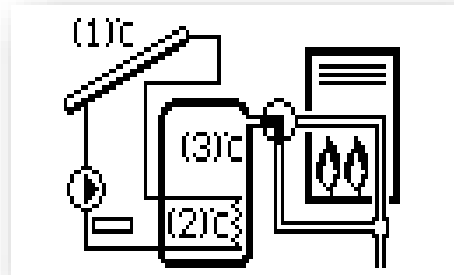

The system includes a dual function boiler which heats the circuit. In case of too low tank temperature the valve switches to the CH boiler.

Additional parameters to be configured (additional submenu in service menu):

- Options: heating deactivation.

SCHEME 11/17 – CH RETURN HEATING

Installation 11/17 supports:

- collector pump,
- valve switching between direct boiler circulation and through-tank circulation or pump
- accumulation tank with lower and upper circuit
- CH boiler return circuit,
- one direction of collector positioning,
- additional peripherals (no possibility of cooling with DHW pump)

Installation sensors:

- collector sensor,
- two sensors of accumulation tank - upper and lower one
- CH boiler return sensor.

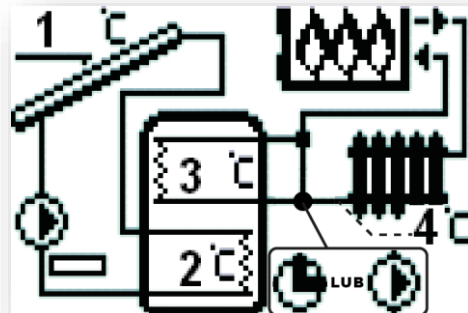

The system includes a valve which switches into CH boiler return circuit if there is too much hot water in the tank in order to heat the return circuit (release the excess heat), which results in fuel saving. A pump may be used instead of valve.

Additional parameters to be configured (additional submenu in service menu):

- Options: energy return threshold, energy return hysteresis, activation delta, deactivation delta

SCHEME 12/17 – TWO COLLECTORS, TWO PUMPS, TANK AND ADDITIONAL HEAT RECEIVER

Installation 12/17 supports:

- two collector pumps (operating independently in separate circuits),
- accumulation tank with lower circuit,
- two directions of collector positioning,
- additional heat receiver,
- valve switching between main circuit and additional receiver

Installation sensors:

- two collector sensors,
- accumulation tank sensor,
- sensor of additional receiver

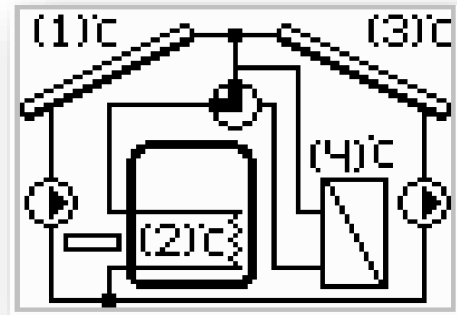

NOTE

No possibility of connecting and selecting an additional device - *Peripherals* submenu is not available in the service menu. Switching valve controlling the additional receiver is connected in the place of peripheral device.

Additional parameters to be configured:

- Pump 2 deactivation delta
- Pump 2 activation delta 2
- Heat receiver : maximum receiver temperature, heat receiver hysteresis

SCHEME 13/17 – TWO COLLECTORS, PUMP, VALVE, TANK AND ADDITIONAL TANK CONNECTED IN SERIES

Installation 13/17 supports:

- collector pump,
- switching valve,
- solar accumulation tank – with lower circuit,
- tank 2 (heated by additional heat source e.g. CH boiler),
- one direction of collector positioning,
- additional peripherals (no possibility of cooling with DHW pump)

Installation sensors:

- collector sensor,
- two sensors of accumulation tank.
- tank 2 sensor

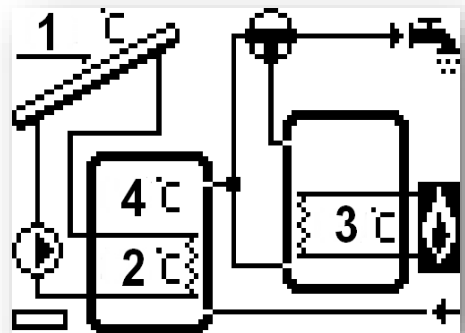

In this system the user may choose the tank which will provide hot water (the controller chooses the tank with higher temperature). During low insolation periods (winter), the water is taken from the tank 2 (heated by the additional heat source e.g. CH boiler) whereas solar collector water, heated by the solar heating system, is transported to tank 2 input as cold water.

Additional parameters to be configured:

- valve hysteresis

SCHEME 14/17 – HEATING CH RETURN

Installation 14/17 supports:

- collector pump,
- valve switching between direct boiler circulation and through-tank circulation
- solar accumulation tank – with lower and upper circuit
- tank 2 (heated by additional heat source e.g. CH boiler),
- one direction of collector positioning,
- tank 2 pump – mixing pump

Installation sensors:

- collector sensor,
- two sensors of accumulation tank.
- tank 2 sensor

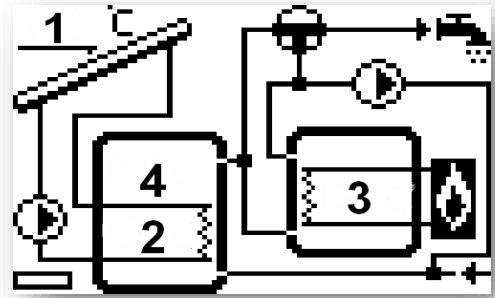

This system automatically chooses the tank which will provide hot water (the regulator selects the tank with higher temperature). During high insolation periods, water in the solar tank may reach very high temperature, which in turn may be transferred to tank 2 in order to heat more water than the solar tank capacity allows.

No possibility of connecting and selecting an additional device - *Peripherals* submenu is not available in the service menu. Switching valve controlling the additional receiver is connected in the place of peripheral device.

Additional parameters to be configured:

- valve hysteresis
- Operation algorithm
- Pump deactivation delta 2
- Pump activation delta 2

SCHEME 15/17

Installation 15/17 supports:

- collector pump
- switching valve
- solar accumulation tank
- tank 2 (heated by additional heat source e.g. CH boiler)
- one direction of collector positioning,
- additional peripherals.

Installation sensors:

- collector sensor,
- two sensors of accumulation tank
- tank 2 sensor

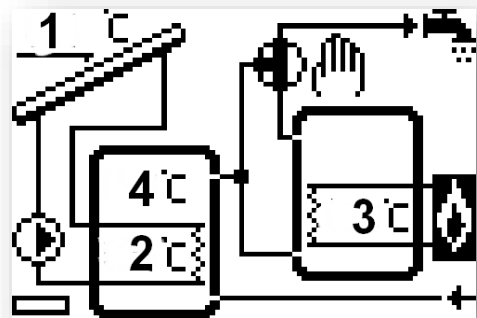

In this system the user may choose the tank which will provide hot water (the controller chooses the tank with higher temperature). During low insolation periods (winter), the water is taken from the tank 2 (heated by the additional heat source e.g. CH boiler) whereas solar collector water, heated by the solar heating system, is transported to tank 2 input as cold water.

SCHEME 16/17

Installation 16/17 supports:

- collector pump
- switching valve
- solar accumulation tank
- one direction of collector positioning
- additional peripherals.

Installation sensors:

- collector sensor
- two sensors of accumulation tank
- valve sensor

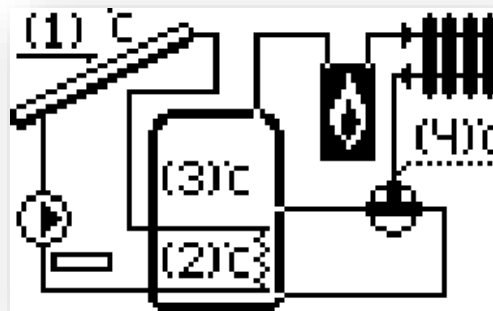

This system enables the user to control CH return valve to the accumulation tank. The valve switches from upper tank circulation to lower tank circulation.

Additional parameters to be configured:

- valve delta

SCHEME 17/17

Installation 17/17 supports:

- collector pump,
- tank -receiver pump
- solar accumulation tank
- heat receiver
- one direction of collector positioning
- additional peripherals.

Installation sensors:

- collector sensor
- two sensors of accumulation tank
- heat receiver sensor



Additional parameters to be configured (additional submenu in service menu):

- Heat receiver: maximum receiver temperature, receiver activation temperature, heat receiver hysteresis.

3.2. ACCMULATION TANK

This menu enables the user to adjust all the parameters related to the tank (heat accumulator).

- **Pre-set temperature** – this function is used to adjust the pre-set tank temperature. After reaching this temperature the collector pump is deactivated.
- **Maximum temperature of tank 1** - using this option, the user may declare the maximum acceptable safe temperature value which the tank can reach in case of collector overheat.

If the collector reaches its alarm temperature (*overheat*), the pump is activated automatically in order to cool down the heated collector, regardless of the pre-set temperature. The pump operates until the tank maximum

temperature is reached or until the collector temperature drops by the value of the *alarm hysteresis* (see: *SERVICE MENU > Solar collector > Alarm hysteresis*).

- **Minimum temperature of tank 1** – using this parameter, the user may declare the minimum acceptable temperature value which the tank can reach. Below this temperature the pump is not activated in collector defrosting mode.
- **Tank hysteresis** – using this function, the user declares the tank hysteresis value. If the tank reaches the pre-set temperature and the pump is deactivated, it will be activated again after the tank temperature drops below the pre-set value by the value of this hysteresis.
- **Cooling to pre-set temperature** - when the collector reaches the overheat temperature, the pump is activated in emergency mode to cool it down. In this case, the heat is transferred to the tank until the maximum temperature is reached. To prevent the accumulation of too hot water in the tank, *Cooling to pre-set temperature* function should be activated. Once activated, when the collector temperature drops below the temperature of the tank, the pump is activated in order to cool down the tank until it reaches the pre-set temperature.
- **Holiday delta** – this function is active only in Holiday mode. This parameter determines how many °C before reaching the collector overheat temperature the pump is activated in order to cool it down. The pump is deactivated after the collector temperature drops by at least 5°C.
- **Valve hysteresis** - Option available only for schemes: 2, 6, 9, 13, 14.

This function determines the value by which the temperature needs to change in order for the valve to switch again.

Scheme 2 and 6: the setting concerns valve control when cooling the collector down in summer mode or alarm mode, as well as when defrosting. The valve hysteresis determines the difference between tanks temperature at which the valve switches to the opposite tank.

Scheme 9: when the pre-set temperature of tank 1 is reached, the valve switches to the heat receiver circulation. The valve switches again after tank 1 temperature drops by the value of valve hysteresis (this is the difference between the tanks temperatures).

Schemes 13 and 14: the regulator controls the switching valve – water from the warmer tank is directed to the facility. The temperature difference is detected automatically, and if this difference reaches the value of the valve delta, the valve switches to the warmer tank.

- **Pre-set temperature of tank 2** - Option available only for schemes 6, 7, 8, 9. This function determines the pre-set temperature of tank 2 at which the collector pump is deactivated (schemes 6 and 9) or tank 2 pump is deactivated (schemes 7, 8).
- **Maximum temperature of tank 2** - Option available only for schemes 6,7,8,9. Using this option, the user may declare the maximum acceptable safe temperature value which tank 2 can reach in case of collector overheating.
- **Tank hysteresis 2** - Option available only for schemes 6, 7, 8, 9. Once the pre-set temperature is reached, the pump is deactivated. It will be activated again after the tank temperature drops below the pre-set value by the value of tank 2 hysteresis.
- **Operation algorithm** - Option available only for schemes 7, 8,14. Using this option, the user selects the pump operation mode. The pumps may operate in the following modes:
 - a) tank 1 priority – tank 1 is heated first (only pump 1 operates). Once the pre-set temperature has been reached, pump 2 is activated and heats tank 2.

- b) parallel operation – the pumps operate independently of each other (according to their settings) and heat both tanks at the same time.
- **Tank heating priority** - Option available only for scheme 9. Once this option has been selected, the pre-set tank temperature is given priority – the valve does not switch to the heat receiver circulation until the pre-set tank temperature is reached. Oscillation charging function does not apply in this situation.

3.3. SOLAR COLLECTOR

These parameters enable the user to configure solar collector operation.

- **Overheat temperature** - it is acceptable alarm temperature of the solar collector at which the pump is forced to activate in order to cool down the solar panels. The discharge of warm water will take place regardless of the tank pre-set temperature. The pump will operate until the tank temperature drops below the alarm temperature by *alarm hysteresis* value (*Service Settings > Solar collector > Alarm hysteresis*) or until the tank reaches the maximum acceptable temperature (*Service settings > Accumulation tank > Maximum temperature*).
- **Minimum heating temperature** - it is the collector threshold temperature. If the collector temperature is higher and starts to drop, the controller disables the pump when the minimum heating temperature is reached. When the collector temperature is below this threshold and starts to increase, the pump is activated when the minimum heating temperature plus hysteresis (3°C) is reached. The threshold heating temperature is not active in the emergency mode, manual mode or collector defrosting.
- **Anti-freeze temperature** - due to the different freezing temperatures of the liquid in the solar installation *anti-freeze temperature* was introduced. This parameter determines the minimum safe temperature at which glycol liquid does not freeze (temperature measured at the collector). In case of a significant drop in the collector temperature (to the value of *anti-freeze temperature*), the pump is activated and operates continuously until the collector reaches safe temperature. The setting range of this parameter is within -50: +10°C.
- **Alarm hysteresis** - Using this function the user sets the value of the collector alarm hysteresis. If the tank reaches the alarm temperature (*Overheat temperature*) and the pump is activated, it will be deactivated again when the collector temperature drops below the maximum temperature by alarm hysteresis value.
- **Defrosting time** – using this function the user determines for how long the pump is enabled once collector defrosting function has been activated.
- **Collector delta** - option available only for scheme no. 4. Only one heating circuit is always active in this configuration. The switching valve switches the circulation to the collector whose temperature is currently higher at least by the value of *collector delta* (it is the difference between the temperatures of the collectors).

3.4. HEAT RECEIVER

This submenu is displayed only for schemes: 12,17.

- **Maximum receiver temperature** - This parameter determines the maximum value of the receiver temperature – as long as the receiver does not reach this value, the tank-receiver pump remains active (provided that the temperature of the upper tank sensor is higher than the temperature of the receiver). Once the temperature is reached, the tank-receiver pump is disabled. The pump will be activated again after the receiver temperature drops by the receiver hysteresis value (provided that the temperature of the upper tank sensor is higher than the temperature of the receiver).

- **Receiver activation temperature** - This parameter concerns the activation of the tank-receiver pump. The pump is activated after the upper tank sensor reaches this value (provided that the temperature of the receiver is lower than the temperature of the upper tank sensor). If the temperature of the upper tank sensor drops below the activation temperature minus the heat receiver hysteresis, the pump is deactivated until the tank temperature increases.
- **Heat receiver hysteresis** - This parameter applies both to the receiver maximum temperature and the receiver activation temperature and the parameter is described in detail above.

3.5. PUMPS

- **Pump revolutions - regulated or constant** - Using this function the user defines the mode of the pump operation: constant revolutions, when the pump operates at all times at full power (when enabled) or regulated revolutions. In the case of regulated revolutions, the user should adjust several additional parameters (see below).
- **Maximum collector temperature** - Using this setting the user declares the value of the collector maximum alarm temperature at which the pump may be damaged. This temperature should be adjusted according to the collector technical specification. Due to the phenomenon of glycol "gelation" at high temperatures and the risk of damaging the solar pump, the pump is deactivated after reaching the maximum alarm temperature (the controller switches to *Collector overheat* mode).
- **Solar pump deactivation delta** - This function determines the difference between the collector temperature and the tank temperature at which the pump is deactivated (so as not to cool down the tank).
- **Solar pump activation delta** - This function determines the difference between the collector temperature and the tank temperature at which the pump is enabled (this is the pump activation threshold).
- **Gear coefficient** - This parameter is available only if regulated revolutions option is selected. When the conditions for the pump activation are met, it is initially activated at minimum speed (*solar pump work minimum*). Then the pump speed increases according to this coefficient which determines the difference (°C) between the collector temperature and the tank temperature at which the pump speeds up by 10%. The gear coefficient applies only to the pump operating revolutions, namely the value of revolutions within the limits of the solar pump work minimum (0% for the gear coefficient) as well as the solar pump work maximum (100% for the gear coefficient). The greater the difference between the collector temperature and the tank temperature, the higher the pump speed.

Example:

If the gear coefficient value is 3, each 3°C difference between the tank temperature and the collector temperature results in 10% increase in pump speed

The table below contains examples of the coefficient values and its results.

	Gear coefficient 3	Gear coefficient 4	Gear coefficient 5	Gear coefficient 6	Pump working revolutions
Δ value (collector temp. - tank temp.)	Δ3	Δ4	Δ5	Δ6	10%
	Δ6	Δ8	Δ10	Δ12	20%
	Δ9	Δ12	Δ15	Δ18	30%
	Δ12	Δ16	Δ20	Δ24	40%
	Δ15	Δ20	Δ25	Δ30	50%

- **Solar pump work minimum** – this parameter is available only if *regulated revolutions* option is selected. Using this setting the user should define the pump minimum initial speed.
- **Solar pump work maximum** – this parameter is available only if *regulated revolutions* option is selected. Using this setting the user should define the pump maximum operating speed (%).
- **Installation sampling** – this function enables the user to activate or deactivate circulation sampling, aimed at updating the temperature reading, by activating the collector pump for a short period of time (when standard conditions of pump activation are not met). Sampling forces short-time activation of the pump after the collector temperature increase of at least 3°C.
- **Oscillation charging** – Option available only for schemes 2, 6, 7, 9. Oscillation charging function is used when the heating system includes a valve switching the circulation from the collector. The first circulation is always the priority circulation and the valve is switched to circuit 1 until the pre-set temperature of this circuit is reached. When the collector temperature is too low to heat circuit 1, oscillation charging of circuit 2 is activated – the valve switches to circuit 2 and the pump operates in cycles: operation (parameter: *Tank 2 maximum heating time*) as well as pause (parameter: *Oscillation pause time*). When the collector temperature is high enough to heat circuit 1, oscillation charging of circuit 2 is no longer necessary – the valve switches to circuit 1. Oscillation charging is aimed at optimizing the use of available solar energy.

When the user deactivates oscillation charging, heating circuit 1 is given absolute priority and switching to circuit 2 heating is possible only after the pre-set temperature of circuit 1 is reached.

In the case of scheme 2, the first circulation is the collector-tank top circulation while the second circulation is collector-tank bottom circulation.

In the case of schemes 6, 7, 9, the first circulation is collector-tank 1 circulation while the second circulation is collector-tank 2 circulation.

- **Oscillation pause** - Option available only for schemes 2, 6, 7, 9. Once the *maximum heating time Z2* is over, it is followed by oscillation pause (the pump is deactivated) ensuring temperature stabilization. When the collector temperature increases sufficiently during the pause, the valve switches to the first circuit. Otherwise, *maximum heating time Z2 cycle* and *oscillation pause* follow again.
- **Maximum heating time Z2** - Option available only for schemes 2, 6, 7, 9. After switching the valve to the second circulation (when the collector temperature is too low to heat the first circuit to its pre-set temperature), this parameter determines how long the circuit is to be heated (if the conditions for switching to the first circulation are still not met).
- **Pump 2 deactivation delta** - Option available only for schemes 3, 7, 8, 12, 14. This function determines the difference between the collector temperature and tank 2 temperature at which the pump is disabled (so as not to cool down the tank).
- **Pump 2 activation delta** - Option available only for schemes 3, 7, 8, 12, 14. This function determines the difference between the collector temperature and tank 2 temperature at which the pump is enabled (pump activation threshold).
- **Control revolutions** - these parameters enable the user to choose the type of PWM pump used:

Increase

It concerns PWM pump whose speed increases when the signal increases.

Decrease

It concerns PWM pump whose speed decreases when the signal increases.

3.6. PERIPHERALS

The user may connect and configure the settings of an additional device. If there is no additional device, the user should select NONE (deactivate). Additional devices to choose from and examples of connections supporting all available installation schemes are presented below. In the case of schemes 12 and 14 it is not possible to connect an additional device - the function is unavailable.

- **Circulating pump** - Once this device is selected, the user should adjust *operation time* and *pause time* of the pump during its activity. Next, the user should define the hours of pump operation using *From hour* and *Through hour* functions. Entering the same times (*from – through*) will result in the device being active throughout the whole day.

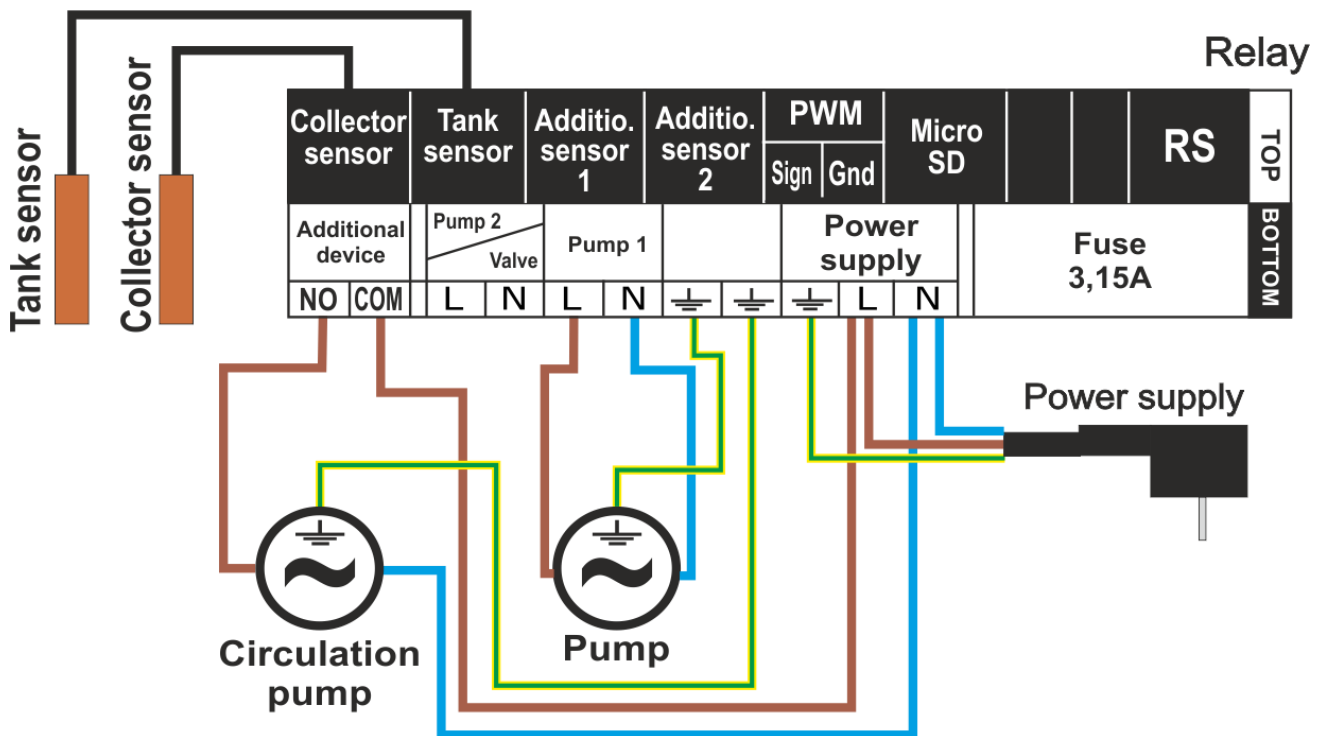

- **PLT (pellet) boiler fire-up** - This option is used to set up the voltage-free signal to fire up the pellet boiler. The user defines *activation delta* - the difference between the pre-set tank temperature and the current tank temperature at which controller sends a signal to fire up the boiler. Next, the user selects the time period throughout which this function will be active (with the use of *from hour* and *through hour* parameters).

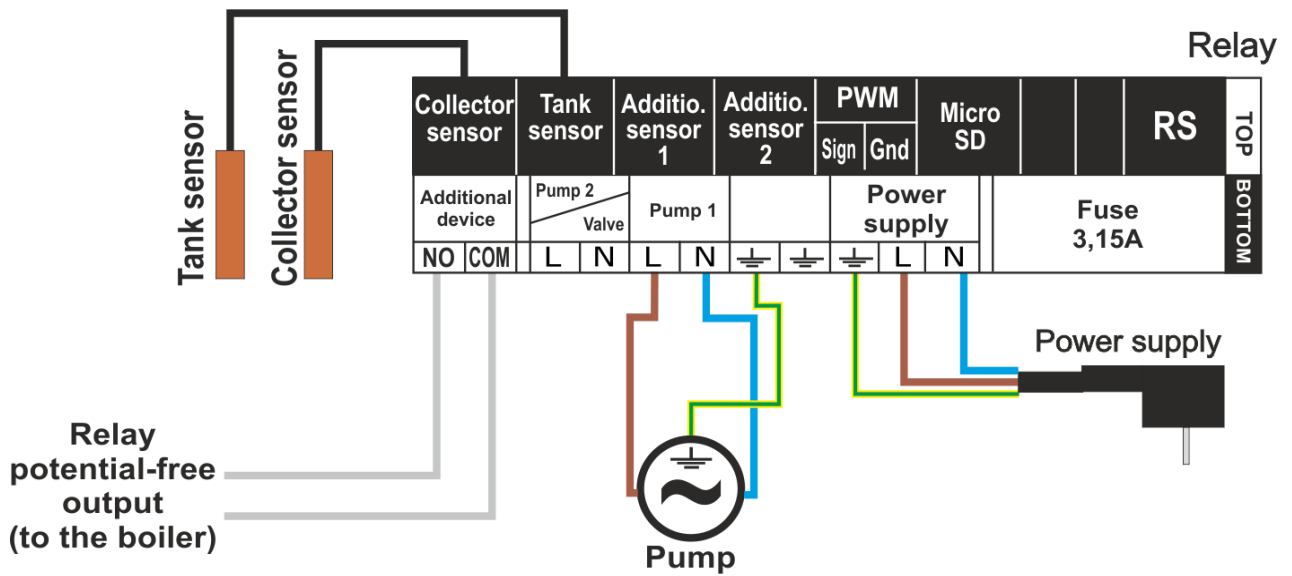

- Heater** - The heater is used to electrically heat the tank. The principle of operation is similar to that in the previous case but the heater should be connected by means of an additional contactor. The user defines the activation delta (the difference between the pre-set tank pre-temperature and current tank temperature) below which the controller activates the heater. Next, the user selects the time period in which the electric heating function will be active (using *from hour* and *through hour* parameters).

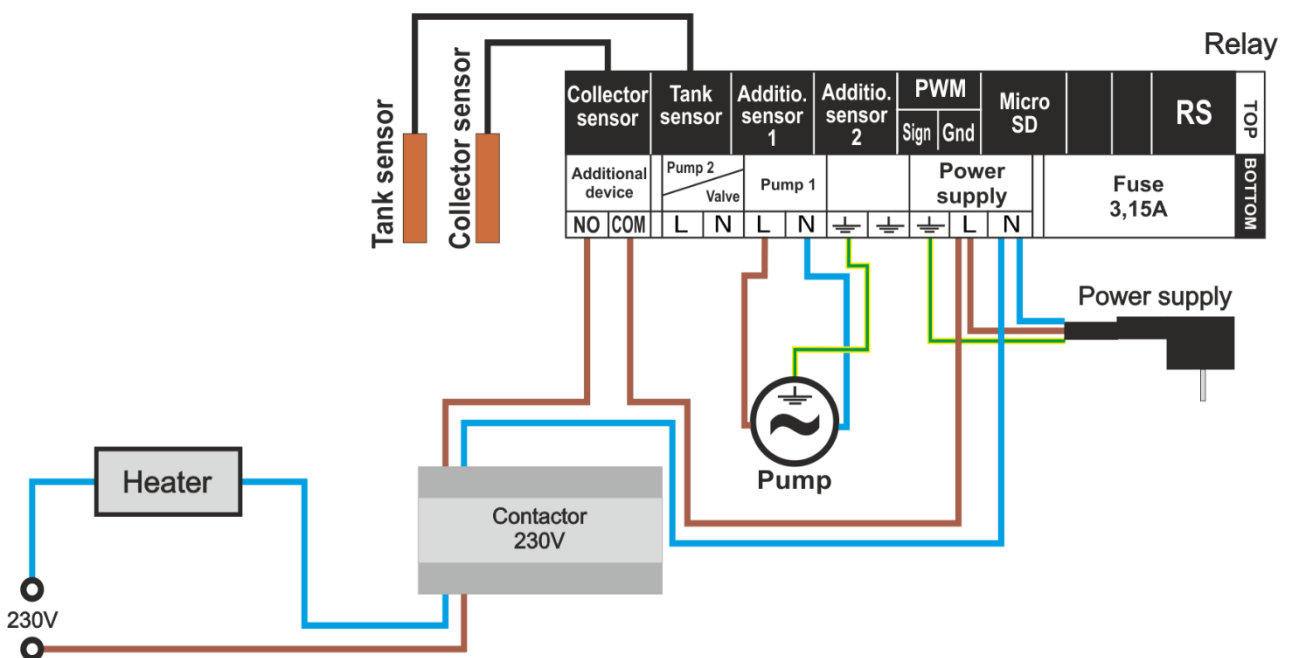

- Contact (in)compatible with pump** - This setting determines the operation of the voltage-free contact. If the option *Contact compatible with pump* is selected, the voltage-free contact will always close when the pump operates (the additional device will be enabled). Otherwise (when the icon is deselected), the contact will open at each activation of the solar pump.

- **Cooling down with DHW pump** - Option not available for schemes 5, 8, 11, 13, 15. This function is active beyond the time period, which means all the time. Sensor 4 is required for it to operate correctly (it should be installed in the external DHW tank). This function will not operate when the installation scheme which includes all sensors is selected. Tank sensor is also necessary for it to operate (in the case of two sensors in the tank - the top sensor).

If the conditions listed above are met, the peripheral device will be activated (contact closing) when:

- the tank temperature during its growth exceeds its maximum temperature reduced by the *cooling activation delta* and operates until the temperature drops below the tank maximum temperature reduced by the *cooling deactivation delta* (both parameters are may be adjusted in the menu).
- the temperature in the tank is higher than the DHW temperature. A constant hysteresis of 3°C is used here.

3.7. ENERGY COUNTING

The following parameters need to be configured to achieve more accurate energy measurement.

- **Number of collectors** – on the basis of the number of collectors the controller calculates how much heat has been produced by the solar installation (energy gain).
- **Flow** - the user should specify the amount of glycol that flows through the pump during one minute.
- **Medium type** - the user chooses the agent used: ethylene glycol, propylene glycol or water.
- **Glycol solution** – the user specifies glycol concentration in water (given in percent).
- **Calibration** - this function allows the user to calibrate the temperature difference between the sensors. The temperature is measured in the place where the temperature sensor is installed. Deviations may occur in the flow and temperature measurement at the tank return. The manufacturer does not recommend changing this setting.

3.8. OPTIONS

This submenu is displayed only for schemes 5, 10, 11.

- **Heating activation delta** - this option is available only in scheme 5. This configuration includes an additional circulation heating the tank with the use of CH boiler. If the tank temperature is lower than the pre-set tank temperature at least by the value of the pre-set activation delta (this is the difference between the pre-set tank temperature and current tank temperature), the auxiliary pump (from the CH boiler) is activated to heat the accumulation tank (provided that the CH boiler temperature is higher than the tank temperature). This setting is active only at the hours defined by the user (*from/through*).
- **From hour.../through hour...** - Option available only for scheme 5. These settings define the hours (*from/through*) when the circulation from the CH boiler heating the accumulation tank is active (see: the previous point).
- **Energy return** - Option available only for scheme 5. Selecting scheme 5 enables energy return (e.g. to the central heating system) above the pre-set tank threshold temperature.
- **Energy return threshold** - Option available only for schemes 5, 11. This parameter defines the threshold tank temperature at which the valve switches to heating the CH boiler return or the pump is enabled.

- **Energy return hysteresis** - Option available only for schemes 5, 11. When the energy return threshold temperature is reached, the valve switches to the CH boiler return circulation. The valve will switch again after the tank cools down by the value of the energy return hysteresis.
- **Solar pump energy return** - Option available only for schemes 5, 11. Schemes 5 and 11 enable the user to deactivate the solar pump, e.g. to cool down the tank using the auxiliary pump.
- **Heating deactivation** - Option available only for scheme 10. In this configuration the tank is heated with a dual function boiler. Heating deactivation concerns the threshold temperature which the tank can reach while heating – if the tank temperature exceeds this value, heating with the use of dual function boiler is deactivated (valve switching).
- **Activation delta (return)** - Option available only for scheme 11. This parameter determines the maximum difference between the tank temperature and the CH boiler return circulation temperature at which the valve switches to heating the CH boiler return.
- **Deactivation delta (return)** - Option available only for scheme 11. This parameter determines the minimum difference between the tank temperature and the boiler return circulation temperature at which the valve switches to standard boiler circulation (without heating).
- **Valve delta** – In this configuration the regulator controls the switching valve. If the temperature of the upper tank sensor is higher than the valve temperature plus the value of the valve delta, the valve switches the circulation to the bottom part of the tank. The circulation will be switched to the upper part again when these temperatures become equal.

3.9. ALARM SOUND

This function enables the user to activate/deactivate the sound signal after an alarm occurs.

3.10. FACTORY SETTINGS

The controller is pre-configured for operation. However, the settings should be customized to the user's needs. Return to factory settings is possible at any time. Once the factory settings option is activated, all customized settings of the solar installation controller (saved in the user's menu) are lost and replaced with the manufacturer's settings. Then, the parameters may be customized anew. Return to factory settings results in activating the default installation scheme.

3.11. EDIT SERVICE CODE

It is possible to edit service menu code. Go to this submenu, enter the code and confirm the settings.

VI. PROTECTIONS

In order to ensure safe and failure-free operation, the controller is equipped with a range of protections.

1. Sensor protection.

If one of the sensors is damaged, an acoustic signal is activated and the following symbol  will appear on the right hand side of the display. An additional icon informing the user which sensor is disconnected or damaged will flash in the place of its temperature. In order to deactivate the alarm signal in case of error, press **EXIT** button.

2. Protection against collector overheating.

If the maximum (alarm) temperature is reached, the regulator switches to the so-called *collector overheat mode* and the

display shows a corresponding symbol . The pump is enabled in order to cool down the collector until the *maximum tank temperature* is reached or until the collector temperature drops by the value of the *alarm hysteresis* (see: *SERVICE MENU > Solar Collector > Alarm Hysteresis*) In the case of two tanks, both of them are used to cool down the overheated collector (at the same time or one by one, depending on the operation algorithm setting).

3. Heat tank protection.

In the event of collector overheating, each tank may be heated to no more than the pre-set maximum safe temperature. After reaching this temperature, the pump of a given tank is disabled (in system configuration with two tanks and a valve, the circulation is switched to the second tank).

4. Fuse.

The regulator is equipped with a WT 3.15A tube fuse-link protecting the network.



NOTE

Higher amperage fuse should not be used as it may lead to controller damage.

VII. SOFTWARE UPDATE



NOTE

Software update shall be conducted only by a qualified fitter. After the software has been updated, it is not possible to restore previous settings.

In order to install new software, the controller must be unplugged from the power supply. Next, insert the flash drive with the new software into the USB port. Connect the controller to the power supply.

VIII. TECHNICAL DATA

Before and during the heating season, **EU-402N** controller should be checked for condition of its cables. The user should also check if the controller is properly mounted and clean it if dusty or dirty.

Power supply	230V \pm 10% / 50Hz
Power consumption	4W
Collector sensor thermal resistance	-30÷180°C
Tray sensor thermal resistance	-30÷99°C
Pump 1 max. output load	0,5A
Pump 2/Valve max. output load	0,5A
Additional output 1 max. output load	1A
Fuse	3,15A

IX. INSTALLATION

The controller should be installed by a qualified electrician! Make sure that the plug is disconnected from the power supply at that time.



NOTE

The cable connecting the temperature sensor should be put in a protective tube and it should not be exposed to weather conditions. The cable connection of the solar controller should be durable, made under shelter and well insulated. Metal parts of the sensor and the collector system should be earthed.

Pictorial diagram - collectors:

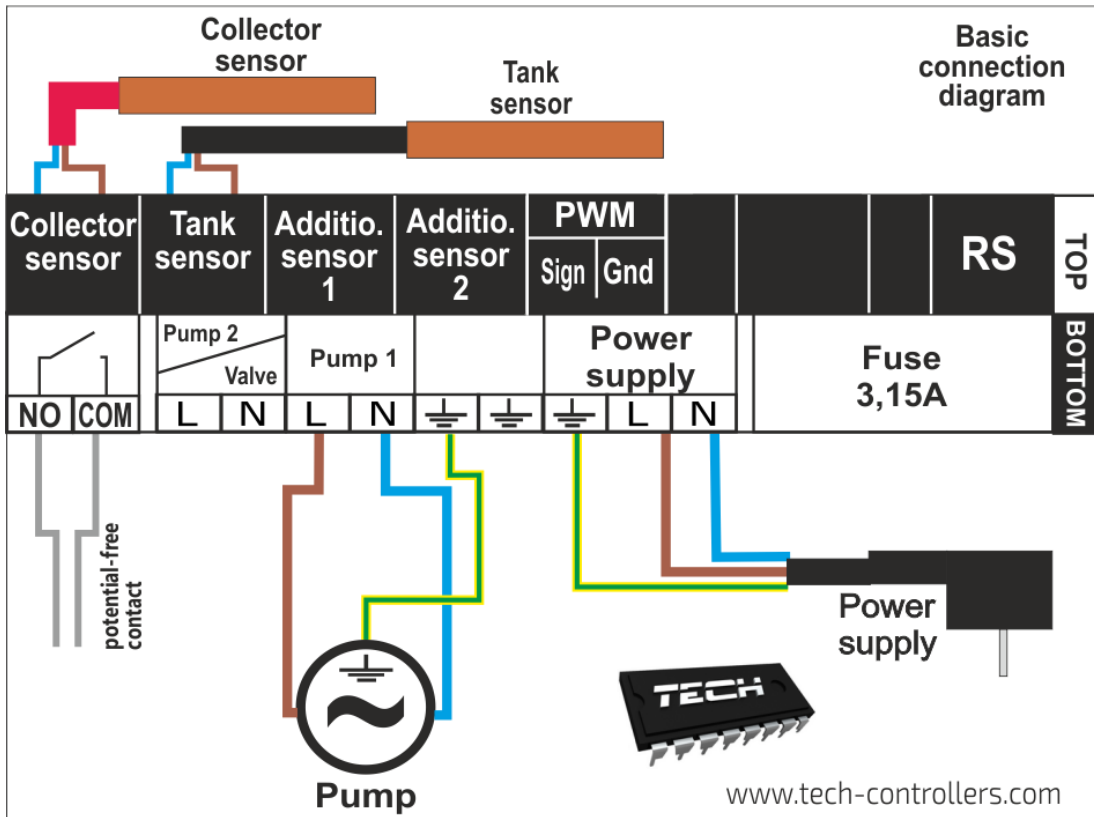

*Pictorial diagram – it cannot replace CH installation project. Its aim is to present how the controller may be expanded.

This heating installation diagram does not include protective elements which are necessary to ensure correct installation.

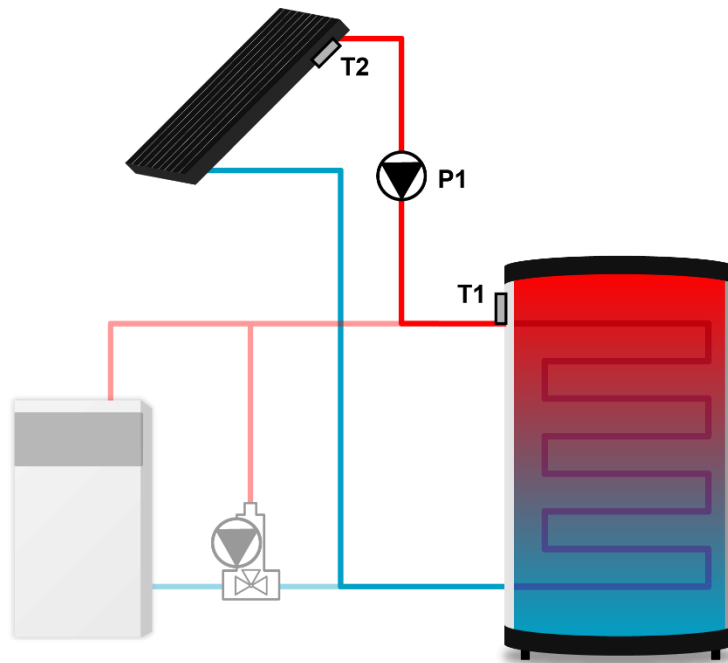

T1 - Heat tank sensor
 T2 - Collector sensor
 P1 - Pump 1

PWM pump connection scheme:

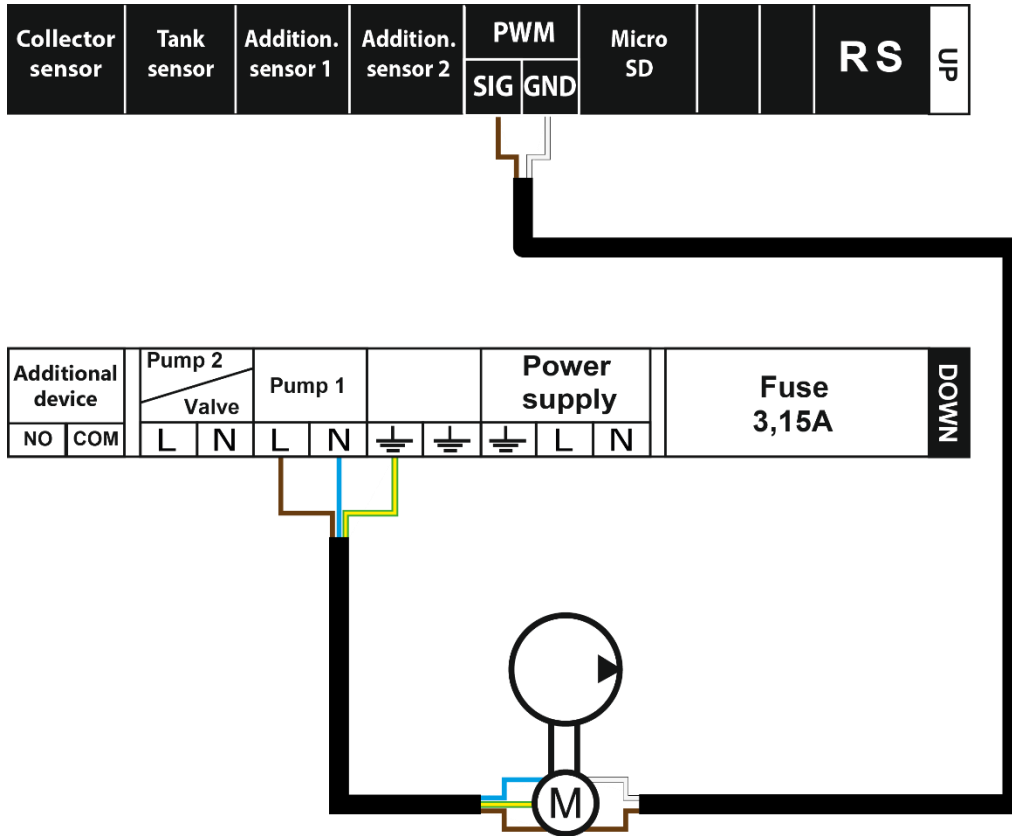



EU DECLARATION OF CONFORMITY

Hereby, we declare under our sole responsibility that **EU-402N PWM** manufactured by TECH STEROWNIKI, head-quartered in Wieprz Biała Droga 31, 34-122 Wieprz, is compliant with Directive **2014/35/EU** of the European Parliament and of the Council of 26 February 2014 on the harmonisation of the laws of Member States relating to **the making available on the market of electrical equipment designed for use within certain voltage limits** (EU OJ L 96, of 29.03.2014, p. 357), Directive **2014/30/EU** of the European Parliament and of the Council of 26 February 2014 on the harmonisation of the laws of Member States relating to **electromagnetic compatibility** (EU OJ L 96 of 29.03.2014, p.79), Directive **2009/125/EC** establishing a framework for the setting of ecodesign requirements for energy-related products as well as the regulation by the MINISTRY OF ENTREPRENEURSHIP AND TECHNOLOGY of 24 June 2019 amending the regulation concerning the essential requirements as regards the restriction of the use of certain hazardous substances in electrical and electronic equipment, implementing provisions of Directive (EU) 2017/2102 of the European Parliament and of the Council of 15 November 2017 amending Directive 2011/65/EU on the restriction of the use of certain hazardous substances in electrical and electronic equipment (OJ L 305, 21.11.2017, p. 8).

For compliance assessment, harmonized standards were used:

PN-EN IEC 60730-2-9:2019-06, PN-EN 60730-1:2016-10.

PAWEŁ JURA

JANUSZ MASTER

Wieprz, 16.03.2022

**TECH
TECH
CONTROLLERS**

Central headquarters:

ul. Biała Droga 31, 34-122 Wieprz

Service:

ul. Skotnica 120, 32-652 Bulowice

phone: **+48 33 875 93 80**

e-mail: **serwis@techsterowniki.pl**

www.tech-controllers.com