

TECH TECH CONTROLLERS

USER MANUAL EU-i-3

EN



TABLE OF CONTENTS

I.	Safety.....	5
II.	Device description.....	6
III.	How to install.....	8
IV.	Main screen description.....	11
1.	Installation screen.....	11
2.	Parameter and panel screen.....	11
V.	Quick setup of the controller.....	12
	Part I. How to configure built-in valves, additional valves and room regulators	
I.	How to configure built-in valve.....	13
II.	Weather-based control.....	17
III.	Mixing valve settings.....	18
IV.	Quick setup of the mixing valve.....	21
V.	Additional valves.....	22
	Part II. Controller operation modes	
I.	Water tank priority.....	23
II.	Parallel pumps.....	23
III.	House heating.....	23
IV.	Summer mode.....	23
V.	Automatic summer mode.....	24
	Part III. DHW pump and Anti-legionella	
I.	How to configure DHW pump operation.....	24
II.	Anti-legionella.....	25
III.	Pump ANTI-STOP.....	26
	Part IV. Manual mode	
I.	Manual mode.....	27
	Part V. Additional contacts	
I.	Voltage contacts and voltage-free contacts.....	28
II.	How to configure a contact.....	29
III.	Voltage and voltage-free contact algorithms.....	30
1.	Circulating pump.....	30
2.	Buffer pump.....	30
3.	CH pump.....	31
4.	Additional heat source.....	32
5.	Buffer.....	33
6.	DHW buffer.....	33

7.	Heating need	34
8.	Operation control	35
9.	DHW	36
10.	Controlling the room regulator	36
11.	Relays	37
12.	Weekly control	37
13.	Manual mode	39
14.	OFF	39

Part VI. Cascade

I.	Cascade	39
1.	Select operation algorithm	39
2.	Operation mode	40
3.	Additional contacts	40
4.	Select sensor	40
5.	Main boiler	40
6.	Reset motohours	40
7.	Factory settings	40

Part VII. Ethernet module

I.	Ethernet module	41
----	-----------------------	----

Part VIII. Solar collector

I.	Solar collector	42
1.	Solar collector	42
2.	Accumulation tank	43
3.	Pump settings	44
4.	Additional contact	44
5.	additional contact 2	44

Part IX. Cooling

1.	Cooling	45
2.	Condition of activation	46
3.	Additional contact	46
4.	Heating circuit	46

Part X. Sensor settings

I.	Sensor settings	47
----	-----------------------	----

Part XI. Factory settings

I.	Factory settings	47
----	------------------------	----

Part XII. Settings

I.	Settings.....	48
1.	Language selection.....	48
2.	Time settings.....	48
3.	Screen settings.....	48
4.	Alarm sounds.....	48
5.	Notifications.....	48
6.	Lock.....	48
7.	Software version.....	49

Part XIII. Weekly control

I.	Weekly control.....	49
	Technical data.....	51
	Protections and alarms.....	52
	Software update.....	53
	Used sensors.....	53

I. SAFETY

Before using the device for the first time the user should read the following regulations carefully. Not obeying the rules included in this manual may lead to personal injuries or controller damage. The user's manual should be stored in a safe place for further reference. In order to avoid accidents and errors it should be ensured that every person using the device has familiarized themselves with the principle of operation as well as security functions of the controller. If the device is to be sold or put in a different place, make sure that the user's manual is there with the device so that any potential user has access to essential information about the device.

The manufacturer does not accept responsibility for any injuries or damage resulting from negligence; therefore, users are obliged to take the necessary safety measures listed in this manual to protect their lives and property.

WARNING

- **High voltage!** Make sure the regulator is disconnected from the mains before performing any activities involving the power supply (plugging cables, installing the device etc.).
- The device should be installed by a qualified electrician.
- Before starting the controller, the user should measure earthing resistance of the electric motors as well as the insulation resistance of the cables.
- The regulator should not be operated by children.
- The device may be damaged if struck by a lightning. Make sure the plug is disconnected from the power supply during storm.
- Any use other than specified by the manufacturer is forbidden.
- Before and during the heating season, the controller should be checked for condition of its cables. The user should also check if the controller is properly mounted and clean it if dusty or dirty.

Changes in the merchandise described in the manual may have been introduced subsequent to its completion on December 4th 2023. The manufacturer retains the right to introduce changes to the structure. The illustrations may include additional equipment. Print technology may result in differences in colours shown.



Care for the natural environment is our priority. Being aware of the fact that we manufacture electronic devices obligates us to dispose of used elements and electronic equipment in a manner which is safe for nature. As a result, the company has received a registry number assigned by the Main Inspector of Environmental Protection. The symbol of a crossed out rubbish bin on a product means that the product must not be thrown out to ordinary waste bins. By segregating waste intended for recycling, we help protect the natural environment. It is the user's responsibility to transfer waste electrical and electronic equipment to the selected collection point for recycling of waste generated from electronic and electrical equipment.

II. DEVICE DESCRIPTION

EU-i-3 controller is a multi-function device intended for controlling central heating systems.

The principle of operation involves mixing the hot supply water with the water returning from the heating circuit in order to reach the desired temperature and maintain it on the same level all the time.

The pump connected to every valve circuit helps to distribute water through the heating system. The pump should be installed downstream of the mixing valve and the temperature sensor should be installed downstream of both the pump and the valve to ensure precise water control at the valve output.

Thanks to advanced software, the controller offers a wide range of functions:

- Smooth control of three mixing valves
- Control of DHW pump
- Protection against too high temperature of CH boiler water as well as too low temperature of water returning to CH boiler
- Weather-based control
- Weekly control
- Two configurable no-voltage outputs
- Two configurable voltage outputs
- Supporting three room regulators with traditional communication (two-state)
- Possibility of connecting 3 dedicated room regulators with RS communication
- Supporting a room regulator with RS communication
- Possibility of connecting ST-505 Ethernet module, ST-525 or WiFi RS which enable the user to control certain functions and view some of the parameters via the Internet
- Possibility of connecting two additional modules controlling the valves (e.g. i-1, i-1m) – it enables the user to control two additional valves
- Possibility of controlling solar panels
- Possibility of controlling CH boiler cascade

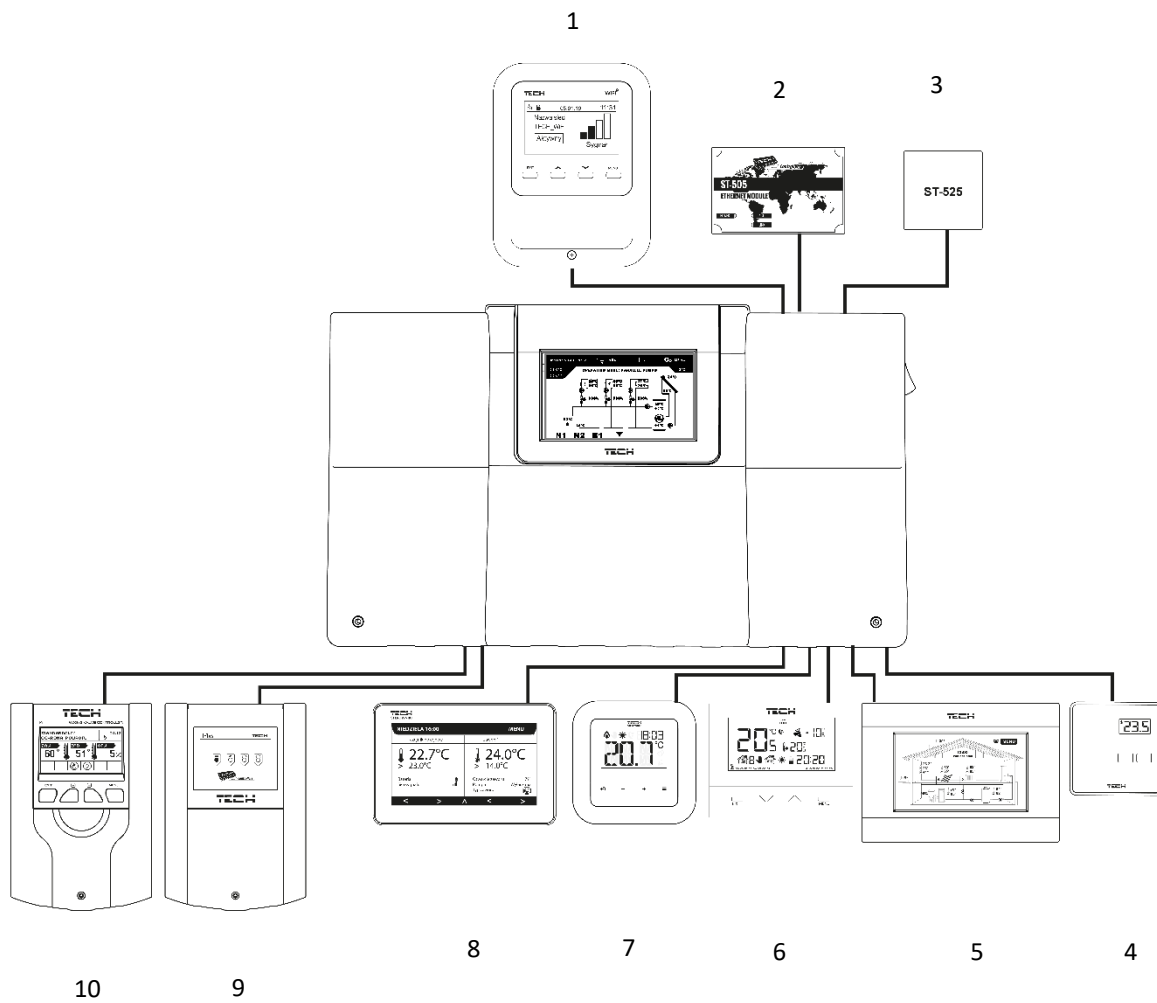

1. WiFi RS
2. ST-505 Internet module
3. ST-525 Internet module
4. ST-294v1 Room regulator
5. ST-280 Room regulator
6. ST-292 Room regulator
7. Dedicated room regulator RI-1
8. Dedicated room regulator RI-2
9. i-1m valve module
10. i-1 valve module

III. HOW TO INSTALL

EU-i-3 controller should be installed by a qualified person. It may be installed as a free-standing device or as a panel mountable on a wall.

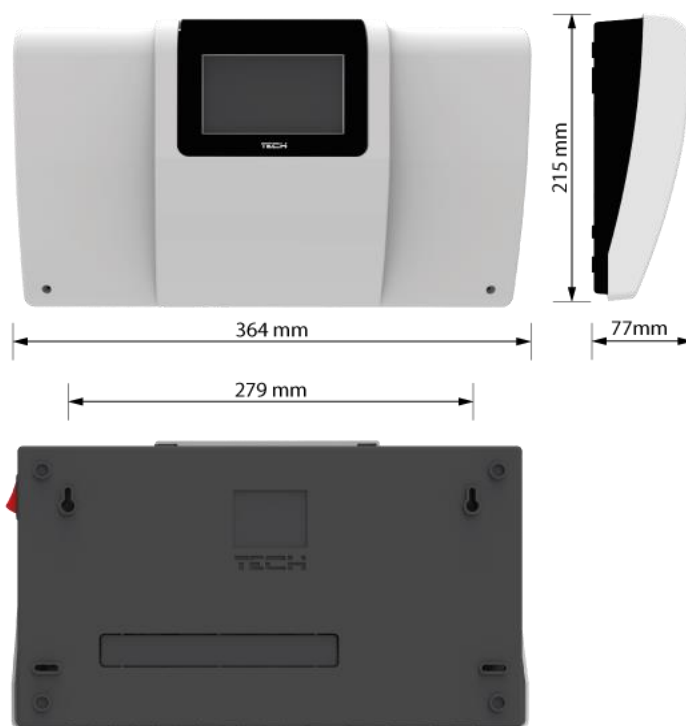

WARNING

Risk of fatal electric shock from touching live connections. Before working on the controller switch off the power supply and prevent it from being accidentally switched on.

Remove the controller cover to connect the wires.

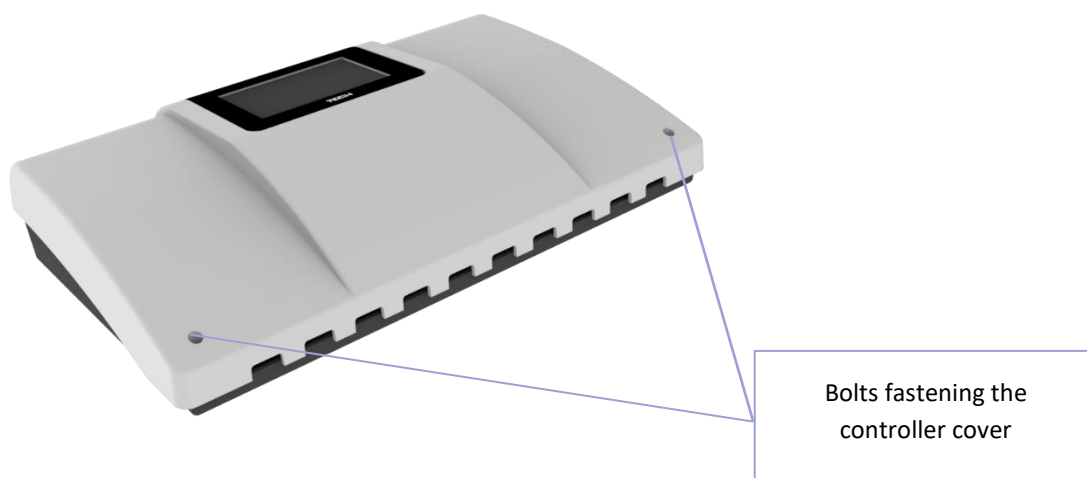

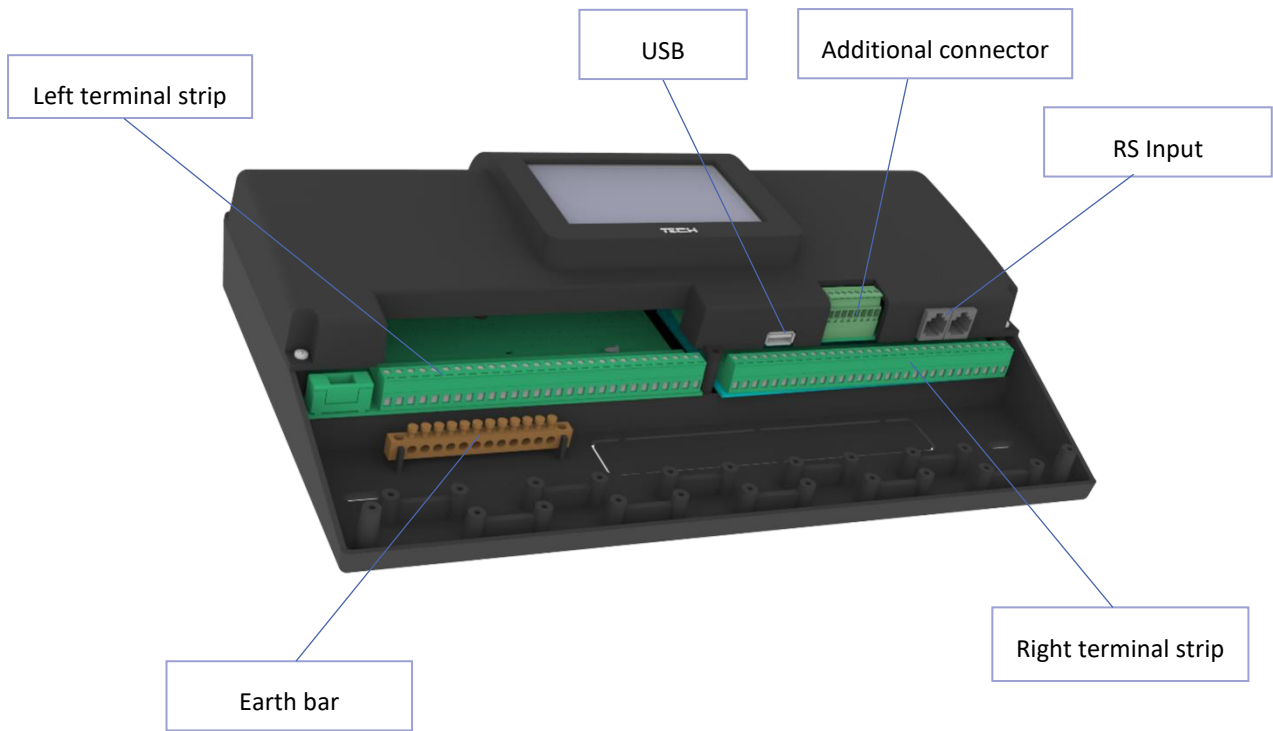

IV. MAIN SCREEN DESCRIPTION

The device is controlled using the touch screen.

1. INSTALLATION SCREEN

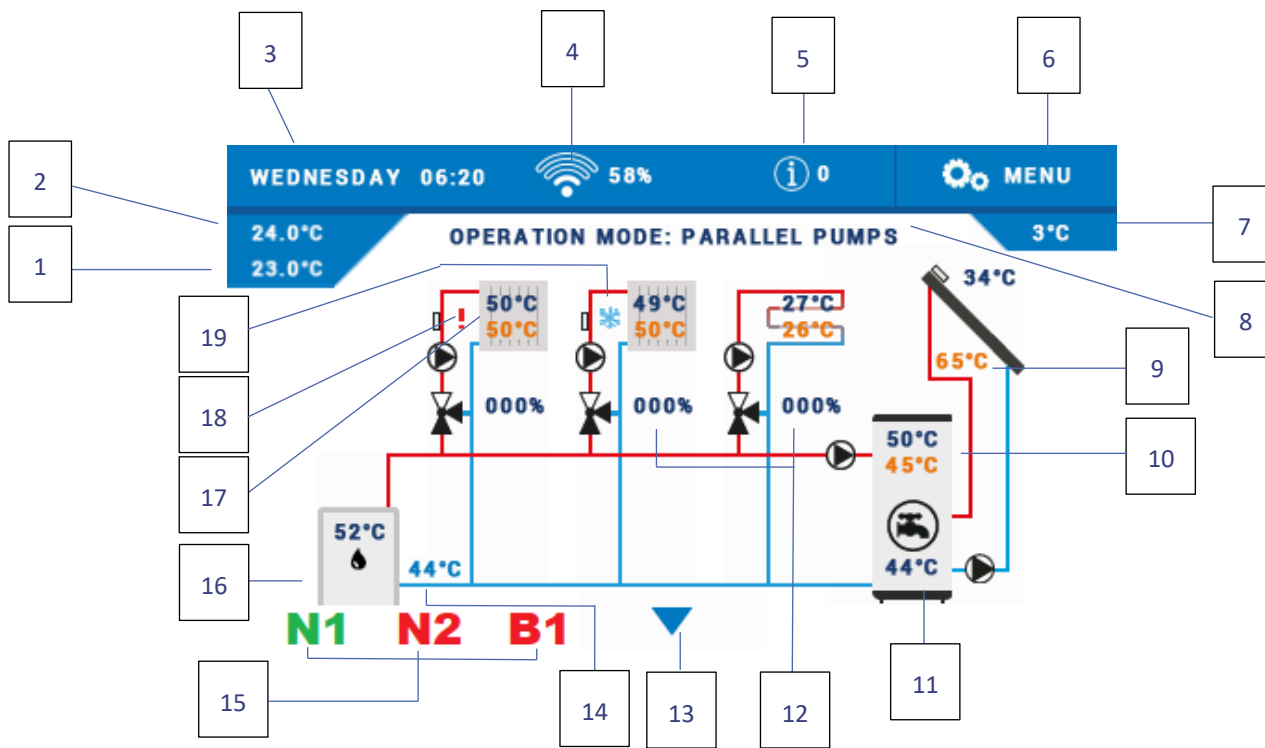

- | | |
|---|---|
| 1. Pre-set room temperature | 12. Level of valve opening [%] |
| 2. Current room temperature | 13. Scroll arrow |
| 3. Day of the week and time | 14. Return temperature |
| 4. Wi-Fi signal strength | 15. Active additional contact (N1, N2 - voltage contacts; B1, B2 - voltage-free contacts) |
| 5. Notification icon | 16. Temperature reading from CH sensor |
| 6. Enter controller menu | 17. Pre-set and current temperature of the heating circuit |
| 7. External temperature | 18. Circuit switched off |
| 8. Current operation mode | 19. Active cooling mode in each circuit |
| 9. Solar collector temperature | |
| 10. Pre-set and current DHW temperature | |
| 11. Accumulation tank temperature | |

2. PARAMETER AND PANEL SCREEN

- **Parameter screen** – a record including the status of all active inputs and outputs
- **Panel screen** – parameters of particular active circuits and algorithms. Tap on a panel to start editing its parameters.

V. QUICK SETUP OF THE CONTROLLER

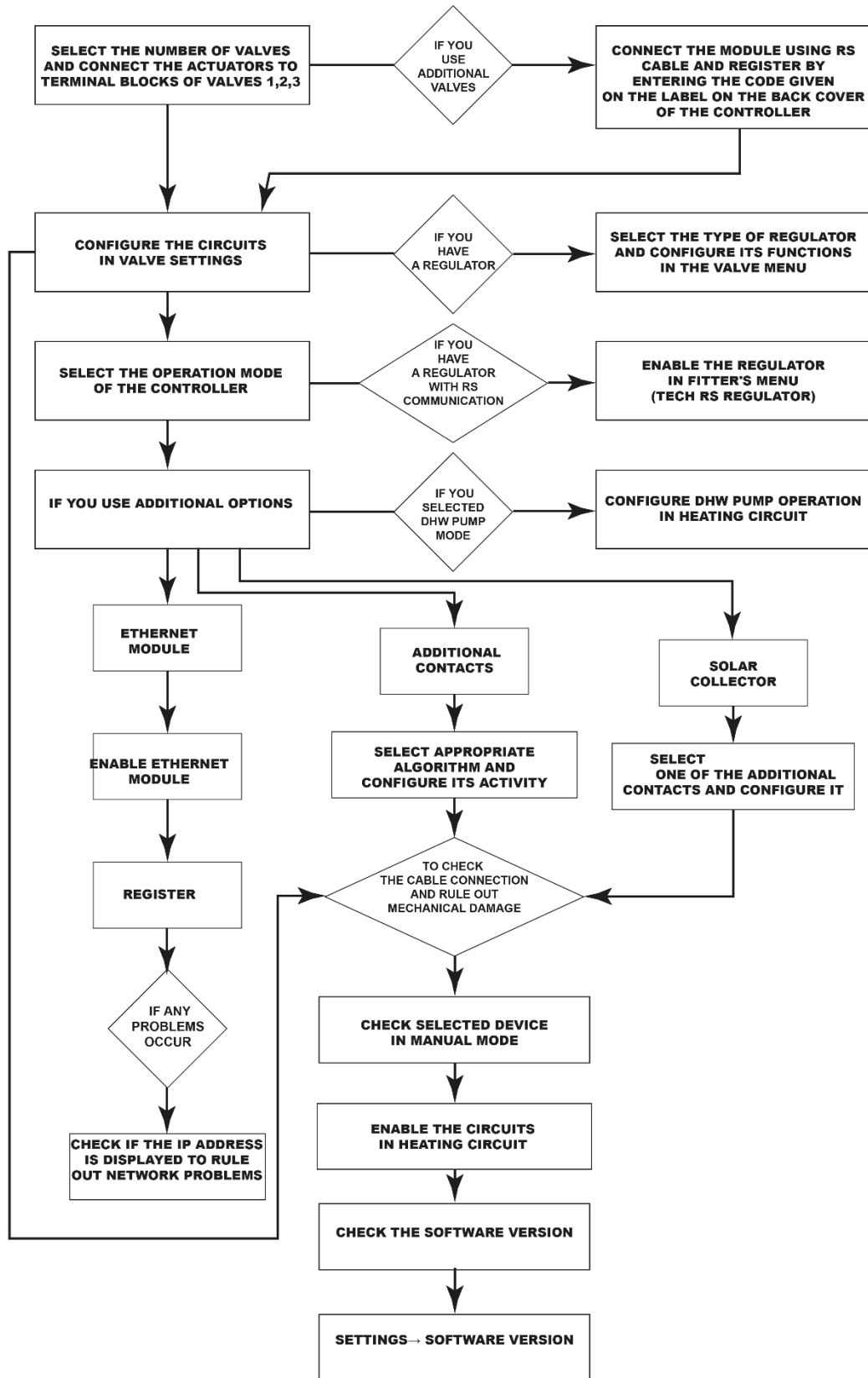

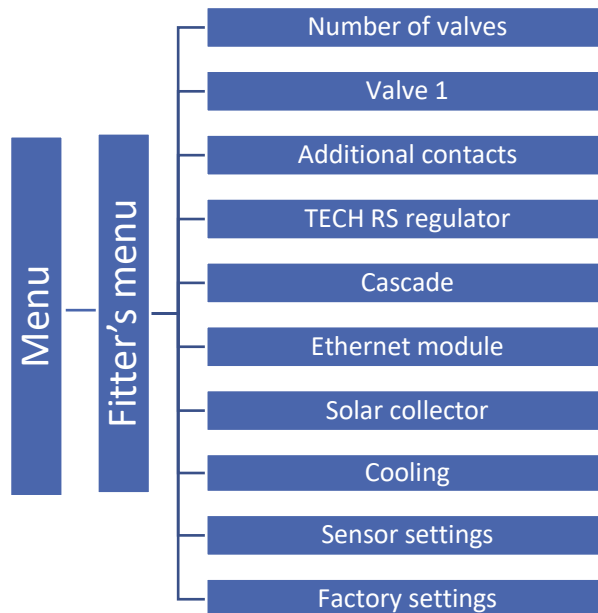

PART I

How to configure built-in valves, additional valves and room regulators

I. HOW TO CONFIGURE BUILT-IN VALVE

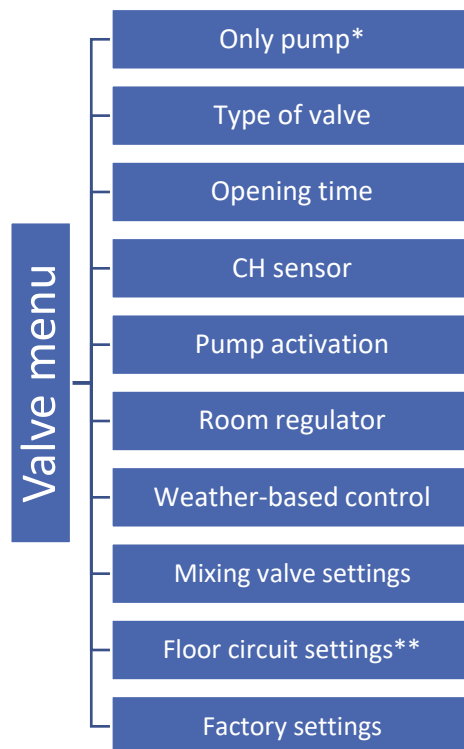

* select in case of circuit operation without a mixing valve

** this option appears when the floor valve type has been selected

1. Enter the fitter's menu
 2. Select the number of valves needed
 3. Configure one of them selecting 'Valve 1' option
 4. Select the type of valve: CH valve, Floor valve, Return protection, Swimming pool, Ventilation. The principle of operation in the case of Swimming pool and Ventilation valves is the same as in the case of CH valve. What changes is the graphics on the installation screen.
- **CO** – select if you want to control the temperature of the CH circuit with the use of a valve sensor. The valve sensor should be installed downstream of the mixing valve in the supply pipe.
 - **FLOOR** – select if you want to control the temperature of the underfloor heating circuit. It protects the underfloor heating system against dangerous temperature. If the user selects CH as the valve type and connects it to the underfloor heating system, the fragile floor installation may be damaged.
 - **RETURN PROTECTION** – select if you want to control the return temperature of the heating system with the use of a return sensor. With this type of valve, only the return sensor and the CH boiler sensor are active; the valve sensor is not connected to the controller. In this configuration, the valve protects the CH boiler return against low temperature, and if the CH boiler protection function is selected, it also protects the CH boiler against overheating. If the valve is closed (0% opening), the water flows only through the short circuit, while full valve opening (100%) means that the short circuit is closed and water flows through the entire heating system.

WARNING

If CH boiler protection is disabled, the CH temperature does not influence the valve opening. In extreme cases, CH boiler overheating is possible; therefore, it is recommended to configure CH boiler protection settings.

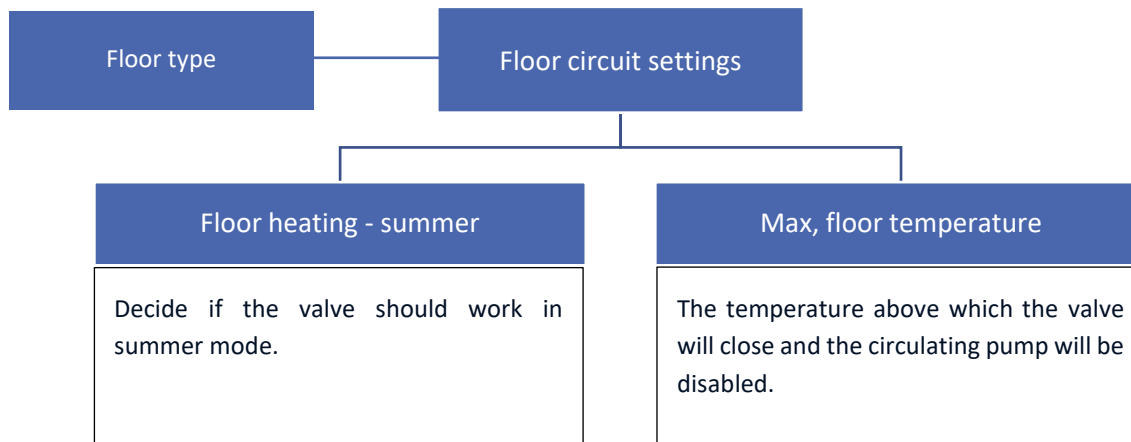

WARNING

If the selected valve type is different from the valve used in the system, it may lead to the whole heating system damage.

NOTE

The controller may support 3 built-in valves and two additional valves.

5. Set the opening time

Opening time is the parameter defining the time needed for the valve actuator to open the valve from 0% to 100%. CH opening time should be the same as the value given on the rating plate of the valve actuator.

Actuator opening time

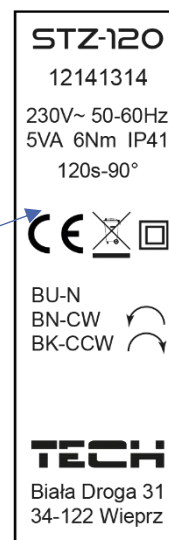

6. Select CH sensor

The selected sensor will serve as CH sensor. The reading from the selected sensor determines the valve pump activation when the function of pump activation above threshold is active.

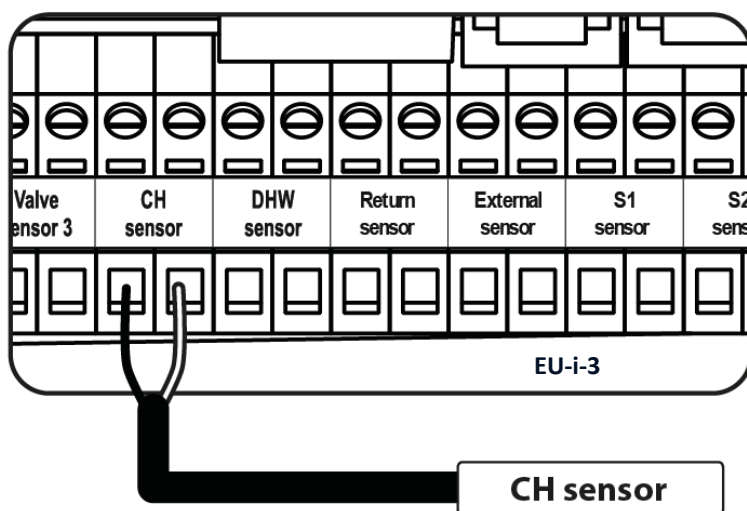

Connecting CH sensor

NOTE
If the CH sensor has not been connected and 'Boiler protection' function is enabled, the controller will inform the user about the lack of sensor through an alarm.

7. Enable the pump

Operation modes:

- Always OFF - the pump is disabled permanently and the device controls only the valve.
- Always ON - the pump operates all the time regardless of the temperature of the heat source and the valve.
- ON above threshold - the pump is enabled above the pre-set activation temperature. The setting range: 10°C - 55 °C.
- Closing below temperature threshold - the valve will close when the temperature drops below the value defined in the parameter *ON above threshold*. As a result, the circuit valve will be disabled.

8. Select one of the regulators in 'Room regulator' (optional). Once the option has been selected, define the type of regulator : standard regulator, TECH RS regulator).

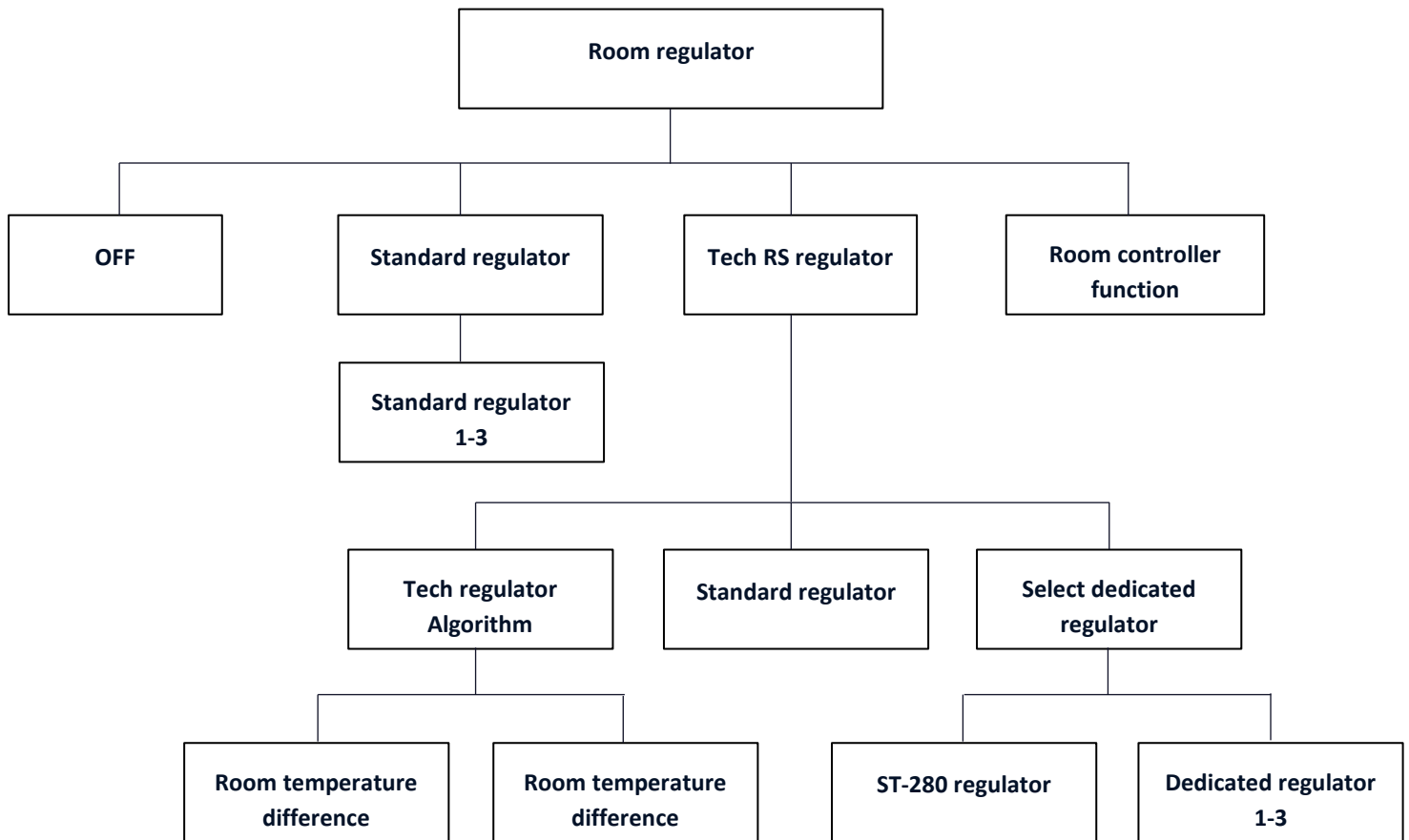

- **Standard regulator** – a two-state regulator operating on an open/closed basis. It offers the following functions: closing, room regulator temperature lower, pump deactivation.
- **Tech regulator Algorithm (Tech RS regulator)** - controlling the pre-set valve temperature on the basis of two parameters: ‘**Room temperature difference**’ and ‘**Change of pre-set valve temperature**’. The pre-set valve temperature is raised or lowered depending on the room temperature. Additionally, it is possible to activate the room regulator functions: **Pump deactivation** and **Closing**.

Example:

Room temperature difference 1°C Change of pre-set valve temperature 2°C
 When the room temperature increases by 1°C, the valve pre-set temperature changes by 2°C.

- **Standard regulator (Tech RS regulator)** – a type of RS regulator operating on the basis of the parameters defined in the room regulator functions: **closing, room regulator temperature lower** and **pump deactivation**.
- **Select dedicated regulator (Tech RS regulator)** - Pre-set valve temperature control is performed via room regulators dedicated to the EU-i-3 controller. The user may register up to 4 dedicated regulators: **the ST-280 regulator** or **Dedicated regulators 1-3**.
- **How to register dedicated regulators:**
 In order to register a dedicated regulator, go to the Menu→Fitter’s menu→Valve (1,2 or 3)→Room reg.→Tech RS reg.→Select dedicated reg. →Dedicated reg. (1,2 or 3). Tap on ‘Dedicated regulator’ (1,2 or 3) to start the registration process of the dedicated regulator. Confirm registration by selecting OK. Next, start the registration process in the regulator. After successful registration, go back to ‘Tech RS regulator’ in order to select the

regulator function: 'Standard regulator' or 'Tech regulator Algorithm' (this step is necessary to ensure proper operation of the regulator). Follow the same steps while registering another regulator.

NOTE

It is possible to register up to 3 dedicated regulators to the controller. A dedicated regulator does not cooperate with additional modules I-1 (it only supports built-in valves).

- **Room regulator functions:**

1. **Closing** - when the room regulator reports that the room temperature is too low, the valve starts closing (to reach the minimum valve opening).

2. **Room regulator temperature lower** - when the regulator reports that the pre-set room temperature has been reached, the pre-set valve temperature will change by the value of 'Room reg. temp. lower' parameter (pre-set temperature - pre-set reduction temperature).

3. **Pump deactivation** - when the room regulator reports that the pre-set room temperature has been reached, the circuit pump will be disabled.

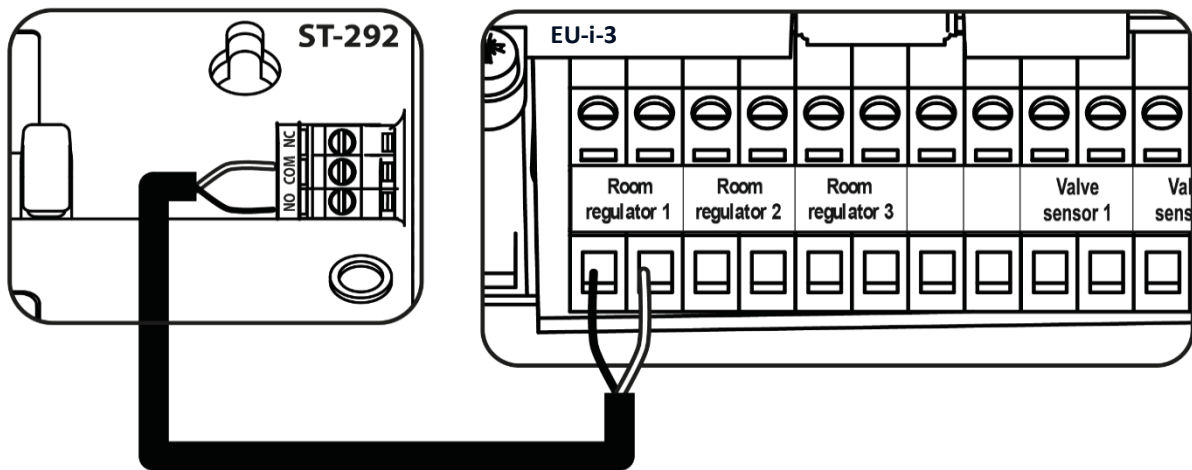

Example connection of a two-state regulator

II. WEATHER-BASED CONTROL

For the function of weather control to be active, the external sensor mustn't be exposed to sunlight or influenced by the weather conditions. After it has been installed in an appropriate place, <weather control> function needs to be activated in the controller menu.

For the valve to operate correctly, the user defines the pre-set temperature (downstream of the valve) for 4 intermediate external temperatures: -20°C, -10°C, 0°C and 10°C.

In order to configure the pre-set temperature value, touch and drag appropriate points up or down (the pre-set valve temperature will be displayed on the left), or use arrows to select the temperature value. Subsequently, the display will show the heating curve.

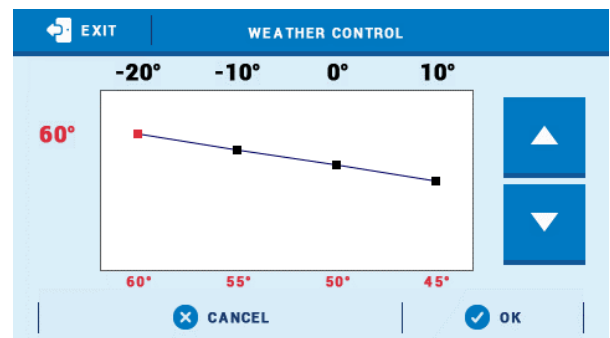

NOTE

This function requires the use of external sensor.

NOTE

Once this option has been activated, it is possible to change the pre-set valve temperature only by selecting the range on the heating curve.

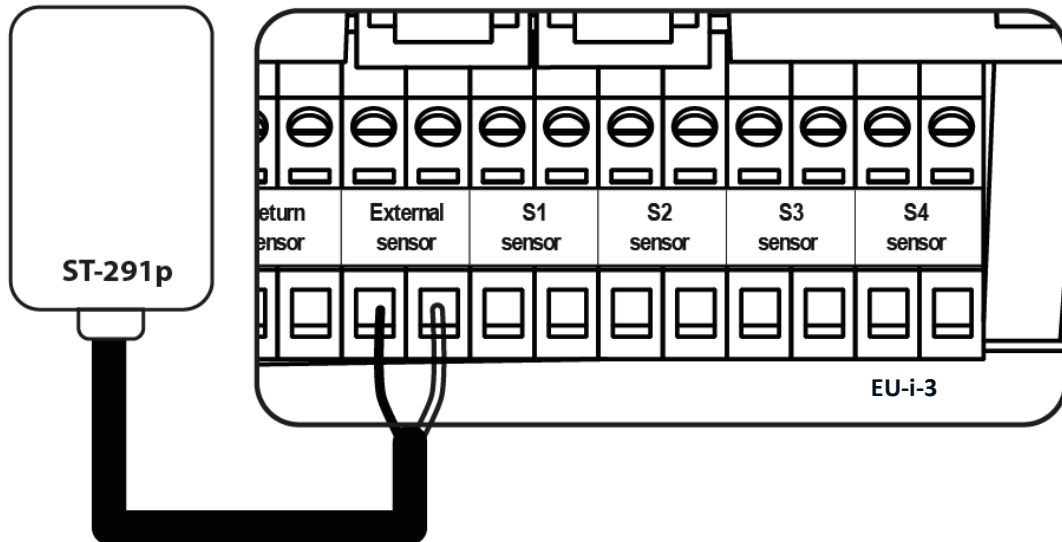

Connecting the external sensor

NOTE

When return protection valve type has been selected, the weather-based control function does not work. The cooling mode has its own heating curve for the weather-based control function: Cooling → Heating circuit → Circuit 1-3 → Heating curve.

NOTE

Further settings of the external sensor are available in *Sensor settings*.

III. MIXING VALVE SETTINGS

- **Temperature control** - This parameter determines the frequency of water temperature measurement (control) behind the CH valve. If the sensor indicates a change in temperature (deviation from the pre-set value), then the valve actuator will open or close by the set stroke, in order to return to the pre-set temperature.
- **Opening direction** - If, after connecting the valve to the controller, it turns out that it is connected the other way round, then the power supply cables do not have to be switched. Instead, it is enough to change the opening direction in this parameter: LEFT or RIGHT. This function is available only for built-in valves.
- **Minimum opening** - The parameter determines the smallest valve opening. Thanks to this parameter, the valve may be opened minimally, to maintain the smallest flow. If you set it at 0°, the valve pump will be disabled.

- **Hysteresis** – the hysteresis between the pre-set temperature and current valve temperature.
- **Single stroke** - This is a maximum single stroke (opening or closing) that the valve may make during one temperature sampling. If the temperature is near the pre-set value, the stroke is calculated on the basis of <proportionality coefficient> parameter value. The smaller the single stroke, the more precisely the set temperature can be achieved. However, it takes longer for the set temperature to be reached.
- **Proportionality coefficient** - Proportionality coefficient is used for defining valve stroke. The closer to the pre-set temperature, the smaller the stroke. If the coefficient value is high, the valve takes less time to open but at the same time the opening degree is less accurate. The following formula is used to calculate the percent of a single opening:

$$(\text{PRE-SET_TEMP} - \text{SENSOR_TEMP}) * (\text{PROP_COEFF} / 10)$$

- **Sensor calibration** - this function enables the user to calibrate the built-in valve at any time. During this process the valve is restored to its safe position – in the case of CH valve it is fully opened whereas in the case of floor valve it is closed.
- Opening in CH calibration – this function enables the user to change the direction of valve opening/closing during calibration.
- **Weekly control** - this function is described in section XIII.
- **Valve deactivation** - once this has been selected, valve operation depends on weekly control settings and external temperature.
 - ✓ **Weekly control** - once this function has been selected, the user may activate/deactivate weekly operation schedule and define the time when the valve will be closed.
 - ✓ **External temperature** - the user may set nighttime and daytime temperature at which the valve will be deactivated. It is also possible to program hours when the controller will operate in day or night mode. The user sets the hysteresis of valve deactivation temperature.

NOTE

The function of Valve deactivation based on outside temperature does not work in cooling mode. The Return protection type does not offer Valve deactivation function.

- **Protections**

- ✓ **Return protection** - this function is used to set CH boiler protection against too cool water returning from the main circuit, which could cause low-temperature boiler corrosion. The return protection involves closing the valve when the temperature is too low, until the short circulation of the boiler reaches appropriate temperature. The user may set the temperature threshold below which the return protection will be activated.

NOTE

To ensure the effectiveness of this protection, it is necessary to activate the valve in the heating circuit menu and connect the return sensor.

- ✓ **CH boiler protection** - this function serves to prevent hazardous growth of CH boiler temperature. The user sets the maximum acceptable CH boiler temperature. In case of hazardous growth in the temperature, the valve begins to open in order to cool the CH boiler down. This function is disabled by default.

NOTE

This option is unavailable for floor valves.

IV. QUICK SETUP OF THE MIXING VALVE

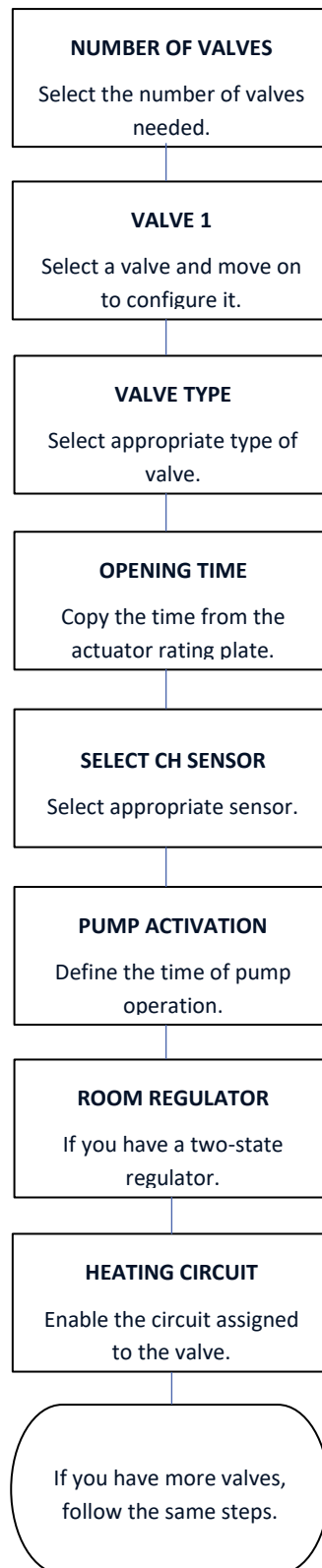

V. ADDITIONAL VALVES

Registration:

1. Connect additional valve to the main controller using RS cable
2. Fitter's menu -> select the number of additional valves
3. Find the additional valve, go to registration and enter the code from the additional module.

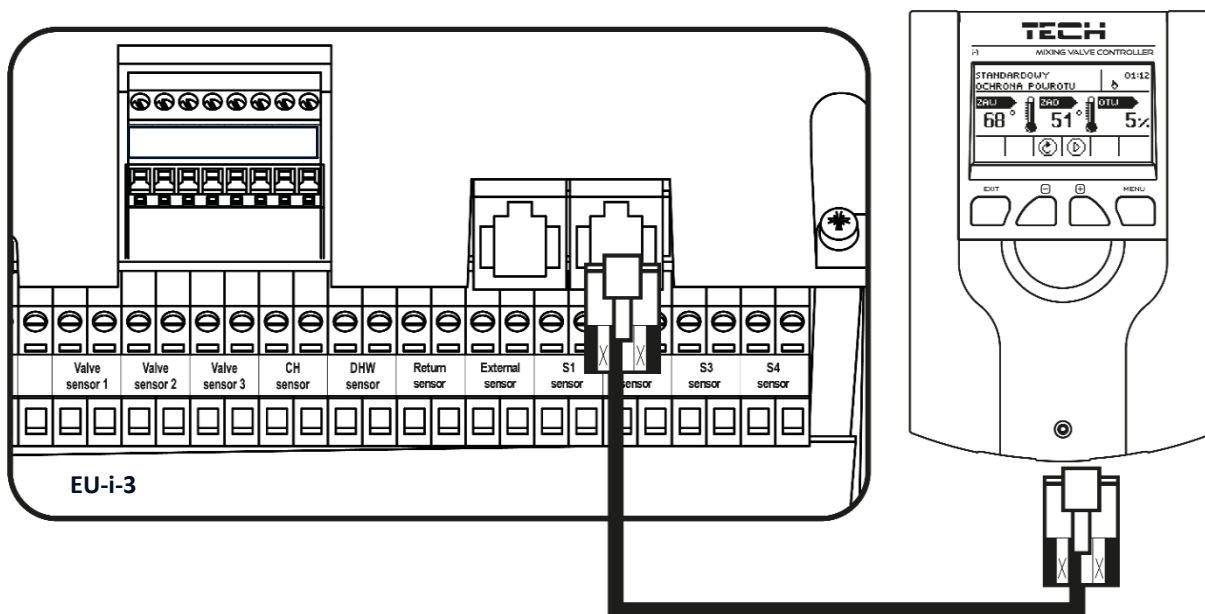

Example connection between additional valve and EU-i-3 main controller

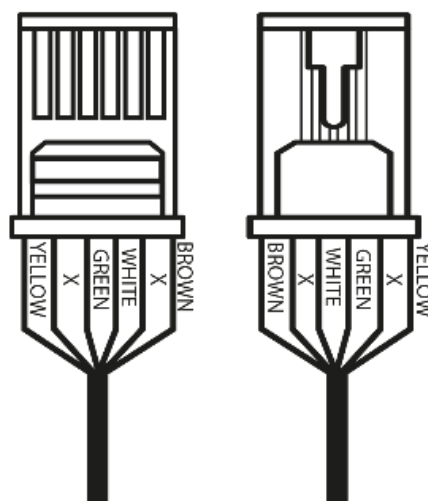

NOTE

An exclamation mark next to the circuit icon means that the circuit is disabled or the additional valve has not been registered.

NOTE

Registration code consists of 5 digits and can be found on the rating plate on the back of i-1m. In the case of i-1 valve controller, the code can be found in software version submenu.

PART II

Controller operation modes



I. WATER TANK PRIORITY

In this mode, water tank pump (DHW) is activated first in order to heat domestic water. Mixing valves are activated once the pre-set DHW temperature has been reached. The valves operate continuously until the water tank temperature drops below the pre-set value by the pre-defined hysteresis.

NOTE

The valves close to 0% opening.

NOTE

When the CH boiler protection is activated, the valves will open even if the water tank temperature is too low.

NOTE

Return protection opens the valve to 5% if the water tank temperature is too low.

II. PARALLEL PUMPS

In this mode, all pumps and valves operate simultaneously. The valves maintain the pre-set temperature and the water tank is heated to the pre-set temperature.

III. HOUSE HEATING

In this mode, only the house circuit is heated and the main task of the controller is to maintain the pre-set valve temperature.

NOTE

DHW pump scheme will be displayed although the house heating mode is active.

To delete the pump image from the scheme, it is necessary to deactivate it in 'Operation modes' of DHW pump.

NOTE

To avoid an alarm being activated when the DHW sensor is not connected, disable the DHW pump in 'Operation modes' of DHW pump.

IV. SUMMER MODE

In this mode, the CH valves are closed to prevent unnecessary house heating. If the CH boiler temperature is too high, the valve will be opened as an emergency procedure (it requires activating 'CH boiler protection' function).

V. AUTOMATIC SUMMER MODE

This option involves automatic switching between modes. When the external temperature exceeds the activation threshold of Summer automatic mode, the valves will close. When the external sensor detects that a given threshold has been exceeded, the controller switches to summer mode. Average temperature is calculated on an ongoing basis. When it is lower than the pre-set value, the operation mode will switch to the previous one.

- **Summer mode temperature threshold** – this option enables the user to set the outside temperature value above which summer mode will be enabled.
- **Averaging time** – the user defines the period of time which will be used to calculate the average outside temperature.

NOTE
This function requires the external sensor to be active.

U NOTE
When the temperature drops below the threshold, the controller will switch to the previous mode.

NOTE
When the connection is configured for the first time and the controller fails to switch the mode, it is necessary to reset it. It results from averaging time (Fitter's menu > sensor settings).

PART III

DHW pump and Anti-legionella



I. HOW TO CONFIGURE DHW PUMP OPERATION

- **Operation mode**

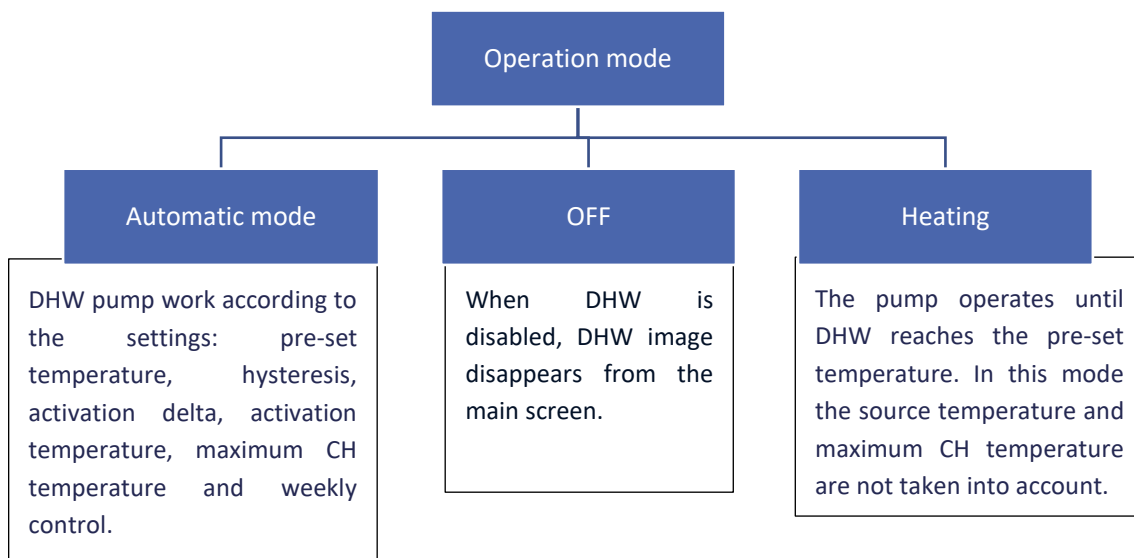

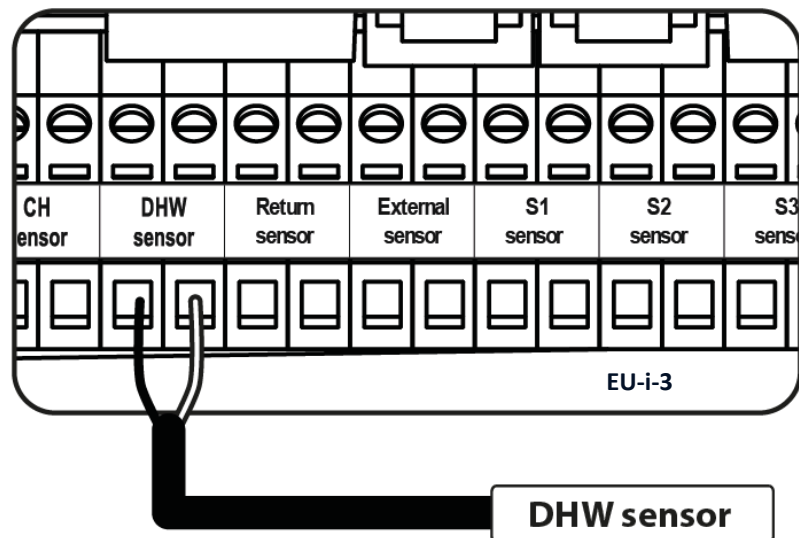

Connecting DHW sensor

- **Pre-set DHW temperature** - This option is used to define the pre-set temperature of domestic hot water. Once the temperature is reached, the pump is disabled.
- **DHW hysteresis** - the temperature difference between device activation and its deactivation (e.g. when the *pre-set temperature* is set at 60°C and the hysteresis value is 3°C, the device will be disabled when the temperature reaches 60°C and it will be activated again when the temperature drops to 57°C).
- **Activation delta** – this function is displayed only in automatic operation mode. It is the minimum difference between DHW temperature and CH temperature which is necessary for the pump is enabled. For example, if activation delta is 2°C, CH pump will be enabled when the source temperature will exceed current DHW tank temperature by 2°C provided that the activation threshold has been reached.
- **DHW pump activation temperature** - this parameter defines the CH temperature which must be reached to enable the pump.
- **Maximum CH temperature** - this parameter defines the temperature above which the pump will be enabled to transfer the excess of hot water to water tank.
- **Weekly control** - this function is described in section XIII.
- **Source sensor** - this function enables the user to choose the source sensor which will provide temperature data.

II. ANTI-LEGIONELLA

Thermal disinfection involves increasing the temperature to the required disinfection temperature in the tank - reading from the upper sensor of the tank. Its aim is to eliminate Legionella pneumophila, which reduces the cellular immunity of the body. The bacteria often multiply in hot water reservoirs. After activating this function, the water tank is heated up to a certain temperature (Heating circuit> DHW pump> Anti-legionella> Pre-set temperature) and the temperature is maintained for a specified disinfection time (Heating circuit> DHW pump> Anti-legionella> Operation time). Next, standard operation mode is restored.

From the moment the disinfection is activated, the disinfection temperature must be reached within the time set by the user (Heating circuit> DHW pump> Anti-legionella> Max. time of disinfection heating). Otherwise, this function will be deactivated automatically.

Using <Automatic operation> function, the user can define the day of the week when thermal disinfection will be carried out.

- **Operation** – manual activation of the disinfection procedure, which is based on ‘Operation time’ and ‘Max. time of disinfection heating’.
- **Automatic operation** – activation of the disinfection procedure based on weekly schedule.
- **Pre-set temperature** – the temperature maintained throughout disinfection process.
- **Operation time** – this function is used to set the duration time of disinfection (in minutes) throughout which the temperature will be maintained at a pre-set level.
- **Max. time of disinfection heating** – it is the maximum time of thermal disinfection process (LEGIONELLA function) from the moment of its activation (regardless of the temperature at that time). If the water tank fails to reach or maintain the pre-set disinfection temperature throughout the whole disinfection period, the controller returns to basic operation mode after the time defined in this parameter.

III. PUMP ANTI-STOP



When this function is active, the valve pump is enabled every 10 days for 5 minutes. It forces pump operation and prevents scale deposit outside the heating season when the pump inactivity periods are long.

PART IV

Manual mode

I. MANUAL MODE

This function enables the user to check if every device works properly by switching on each device separately: DHW pump, additional contacts and valves. In the case of valves, it is possible to initiate opening and closing as well as check if the pump of a given valve works properly.

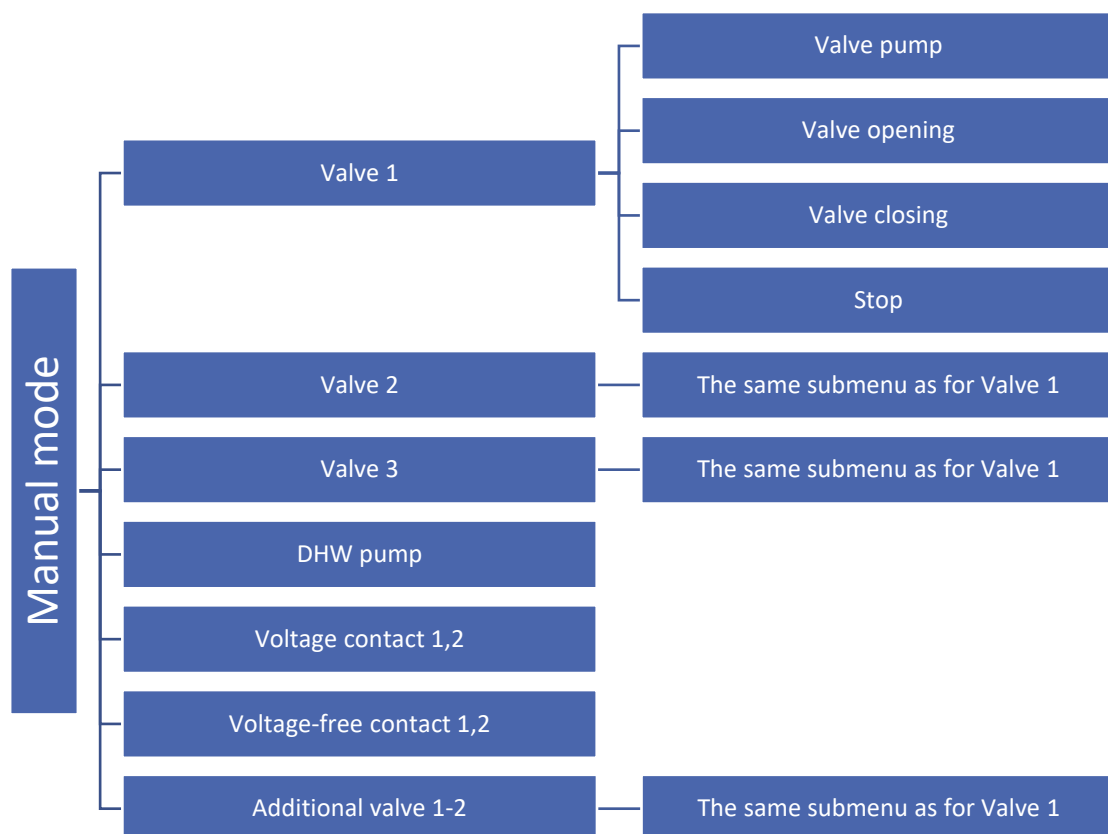

NOTE

Additional valves appear in manual mode only after they have been registered.

Draw your heating system scheme including all active valves and devices connected to additional contacts. It will help you to configure your heating system.

Blank space for your scheme:

PART V

Additional contacts

I. VOLTAGE CONTACTS AND VOLTAGE-FREE CONTACTS

An example connection scheme involves contact 1. In reality it may be any other contact.

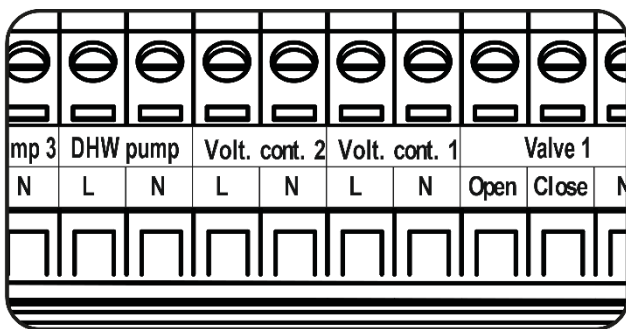

NOTE

Voltage contacts 1, 2 are intended for connecting devices powered by 230V.

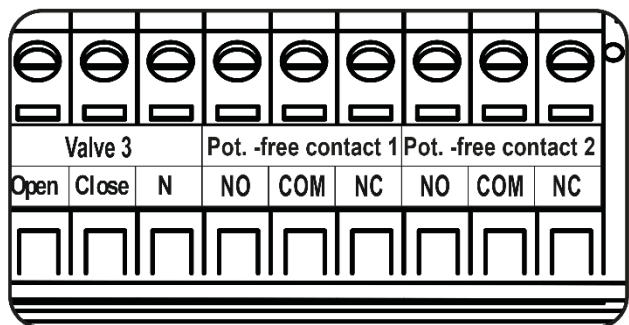

NOTE

Voltage-free contacts 1,2 operate on 'open/close' basis.

II. HOW TO CONFIGURE A CONTACT

CONFIGURE THE CONTACT

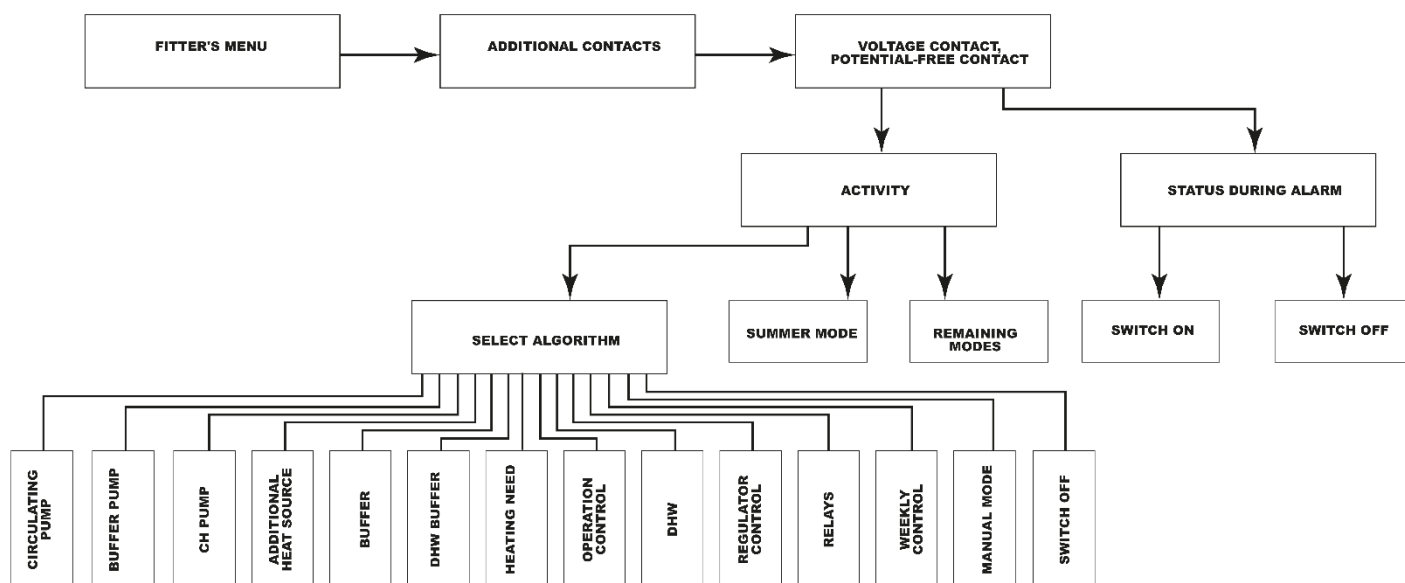

In each algorithm the user may configure the following parameters:

- Activity – operation in summer mode, in the remaining modes or in both cases.
- Status during alarm – this function enables the user to decide if the device connected to this additional contact should be switched on (operating according to the selected algorithm) or switched off during an alarm.

NOTE

This section includes pictorial diagrams of system connections. They cannot replace CH installation project. Their main aim is to present how the controller system may be expanded.

III. VOLTAGE AND VOLTAGE-FREE CONTACT ALGORITHMS

1. CIRCULATING PUMP

This algorithm is intended for controlling the operation of e.g. a circulating pump. The user may select the operation mode and adjust the pre-set temperature as well as the operation time and pause time of the contact. Once the algorithm has been selected, the installation screen shows a graphic representation of the circuit.

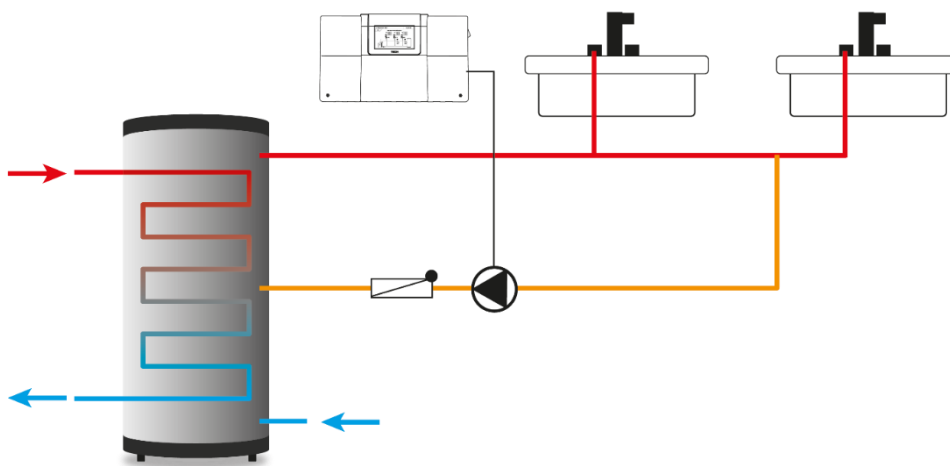

An example connection and control of the circulating pump

Operation modes:

1. **Weekly control** – select the days and time periods when the circulating pump connected to the contact will be active. During these periods the contact will operate according to the following parameters: operation time, pause time and pre-set temperature.
2. **Automatic operation** – the contact operation is based on operation time and operation pause parameters.

2. BUFFER PUMP

This algorithm is intended for controlling the operation of e.g. buffer pump according to temperature readings from two sensors: the source sensor and the buffer sensor.

Condition for activation:

The device connected to the contact will be enabled when the temperature read by the source sensor is higher than the temperature read by the buffer sensor by the value of activation delta. The device will be disabled if the activation condition has been met and the buffer sensor temperature increases by the hysteresis value.

- **Activation delta** – the user may define the difference between the source temperature and the buffer temperature.
- **Activation threshold** – the user may define the threshold temperature for the device activation (read by the source sensor).
- **Hysteresis** - the user may define the value at which the contact will be disabled (if the activation condition has been met).
- **Buffer sensor** – the user may select the sensor.
- **Source sensor** – the user may select the sensor.

Example:

Activation delta: 10°C

Hysteresis: 2°C

Source temperature: 70°C

The device connected to the contact will be enabled when the buffer temperature drops below 60°C (source temp. - delta). It will be disabled when the temperature increases to 62°C (Source temp. - delta) + hysteresis.

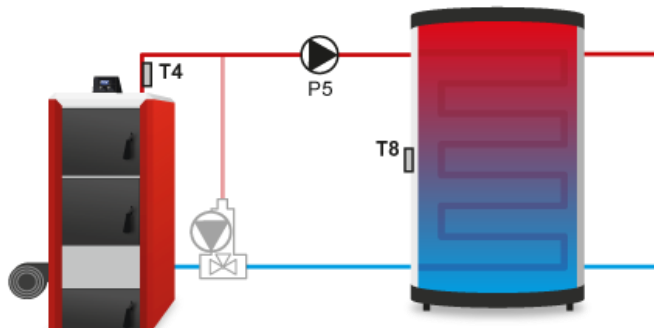

3. CH PUMP

This algorithm is intended for controlling the operation of e.g. CH pump according to the readings from one temperature sensor. The device connected to the contact will be enabled when the activation threshold temperature has been reached. It will be disabled when the temperature drops (including hysteresis).

- **Range (additional settings)** – select this option to create a temperature range within which the CH pump will operate.
- **Activation threshold** – select this option to set the temperature value above which the contact will be enabled.
- **Deactivation threshold (additional settings)** – this option appears after the *RANGE* function has been selected. The user may set the temperature value above which the contact will be disabled, taking into account stable overheating value (deactivation threshold + stable overheating value 3°).
- **Hysteresis** – the user may set the temperature value below which the contact will be disabled (Activation Threshold-Hysteresis).
- **Heating need (additional settings)** – it is a pre-set value which will be taken into account when you select the contact with the CH pump operating in *Heating need* algorithm. This function appears after the *RANGE* function has been selected.
- **External temperature (additional settings)** – the contact operates according to external temperature value (if an external temperature sensor is used). The user may set a threshold external temperature at which the contact will be disabled. It will be enabled when the external temperature drops below the threshold and when the activation threshold has been reached.
- **Sensor** – the user may select the heat source sensor.
- **Room regulator** – the user may configure the influence of the room regulators on the contact operation. If this option has been selected, the device connected to the contact will be enabled if the activation threshold has been reached and if any of the selected regulators reports too low temperature (heating need). The device will be disabled when all selected regulators report that the room temperature has been reached.

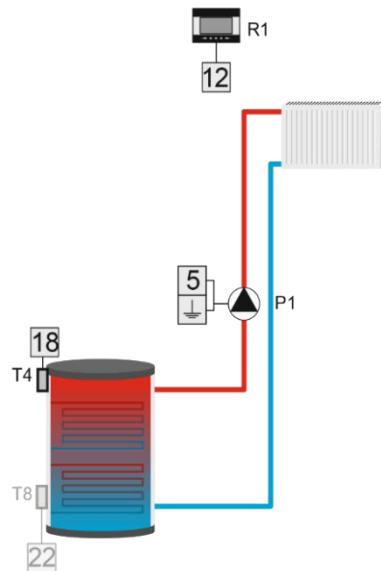

4. ADDITIONAL HEAT SOURCE

The algorithm is based on the readings from one temperature sensor. The device connected to the contact will be enabled when the temperature measured by the sensor drops. It will be disabled when the temperature increases by the pre-set overheating value.

- **Activation threshold** – the user may set the temperature value below which the contact will be enabled.
- **Overheating (additional settings)** - the user may set the temperature value above which the contact will be disabled, taking into account activation threshold (Activation threshold + Overheating threshold).
- **Sensor** – the user may select the heat source sensor which will provide data for contact activation/deactivation.
- **Room regulator** – the user may configure the influence of the room regulators and DHW on the contact operation. If this option has been selected, the device connected to the contact will be enabled if the activation threshold has been reached and if any of the selected options reports too low temperature (heating need). The device will be disabled when all selected options report that the set temperature has been reached or when the condition (Activation threshold+Hysteresis) has been met.

Example:

Part of the CH system is heated by a fireplace and a boiler. The boiler is connected to the voltage-free contact and the fireplace temperature is read by the T4 sensor (CH). The additional heat source will be activated when the sensor temperature drops below the activation threshold. It will operate until the temperature exceeds the threshold value by the overheating value. The device will be disabled when the room regulator informs that the set temperature has been reached or when the temperature read by the T-4 sensor exceeds the activation threshold by the overheating value.

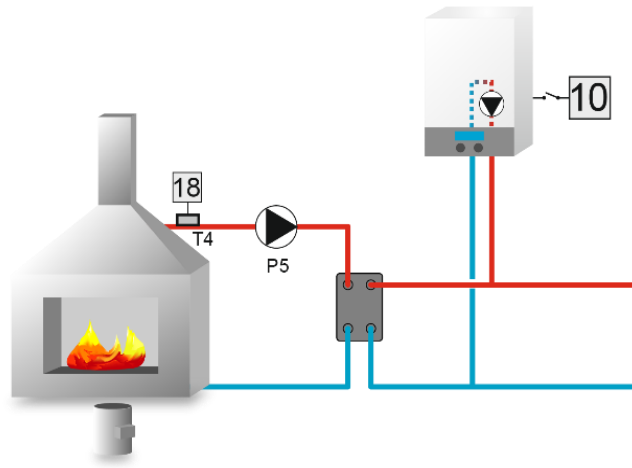

5. BUFFER

The algorithm is based on the readings from two temperature sensors. The device connected to the contact will be enabled when the temperature of both sensors drops below the pre-set value. It will operate until the pre-set temperature of the buffer bottom sensor is reached.

- **Pre-set buffer top** – the user may define the pre-set temperature.
- **Pre-set buffer bottom** – the user may define the pre-set temperature.
- **Top sensor** - the user may select the sensor.
- **Bottom sensor** - the user may select the sensor.

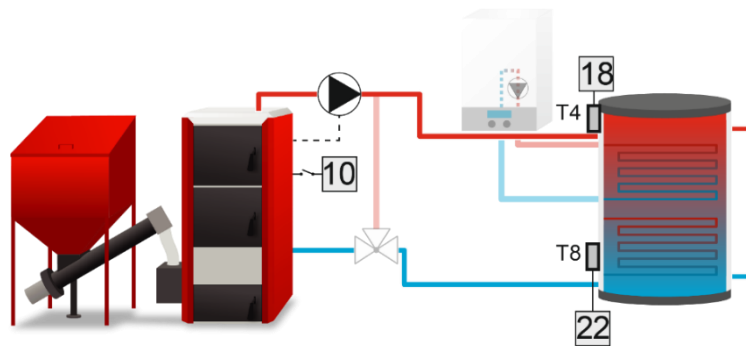

6. DHW BUFFER

The algorithm is based on the readings from two temperature sensors. The device connected to the contact will be enabled if the temperature on any of the sensors drops below the set value by the value of hysteresis. After the pre-set temperature of buffer top has been reached, the device will continue to work for the delay time defined by the user. It will be disabled after the pre-set temperature of both sensors has been reached. It is also possible to set the operation of this device based on a weekly program (described in detail in part XIII), which controls the set temperature of the upper sensor. The user can select which sensor will function as the upper and lower sensor.

- **Pre-set buffer top** - this function enables the user to define the pre-set temperature for the upper part of the buffer (top sensor). Once this value is reached and the delay time is over, the pump is disabled (provided that the pre-set buffer temperature bottom has also been reached).
- **Pre-set buffer bottom** - this function enables the user to define the pre-set temperature for the lower part of the buffer (bottom sensor).
- **Top hysteresis** – the user may set the temperature value at which the contact will be enabled, taking into account pre-set top temperature (Pre-set temperature-Hysteresis).
- **Bottom hysteresis** – the user may set the temperature value at which the contact will be enabled, taking into account pre-set bottom temperature (Pre-set temperature-Hysteresis).
- **Delay** – this function enables the user to define how long the device should remain active after the pre-set buffer temp. top has been reached.
- **Weekly control** - this function is described in detail in section XIII
- **Top sensor** – the user may select the sensor which will function as the top sensor.
- **Bottom sensor** - the user may select the sensor which will function as the bottom sensor.

7. HEATING NEED

The algorithm is based on the readings from one temperature sensor. The device connected to the contact will be enabled if the temperature on the selected sensor drops below the highest set value minus the hysteresis of the selected circuits with a valve. It is also possible to select the DHW circuit; the device will be enabled when the pre-set temperature decreases by the DHW hysteresis. It will be disabled after the highest pre-set temperature of the selected circuits with valves increases by the overheating value, and in the case of DHW - by the the value of DHW overheating, or when the pre-set temperatures in all the selected circuits are reached.

The heating need function may also be based on the operation of the following contacts (after setting the algorithm: CH pump, additional heat source, buffer, DHW buffer).

- **Sensor** - the user may select the sensor to provide readings for the contact operation.
- **Hysteresis** - the user may set the temperature value below which the contact will be enabled, taking into account the pre-set valve temperature (Pre-set temperature-Hysteresis).
- **DHW HYSTERESIS** - the user may set the temperature value below which the contact will be enabled, taking into account the pre-set DHW temperature (Pre-set DHW temperature-Hysteresis).
- **Overheating** – the user may set the value of the pre-set temperature increase for the selected sensor (Pre-set temperature+Overheating).
- **DHW overheating** - the user may set the value of the pre-set temperature increase for the DHW circuit (Pre-set DHW temperature+Overheating).

Example:

The controller controls a system heated with CH boiler connected with a buffer, with an additional heating device with three valves. Boiler is connected to a voltage-free contact and operates in *Heating need* mode. When the temperature of any selected heating circuit is too low and the T4 sensor temperature is too low to heat such a circuit, the additional heat device will be enabled. It will remain active until it reaches the maximum necessary temperature + the pre-set overheating value. The contact will be disabled when this value has been reached or when all selected devices reach their pre-set temperatures. It will be enabled again when the heat source temperature drops below the pre-set value by the hysteresis value or when the selected circuits report too low temperature.

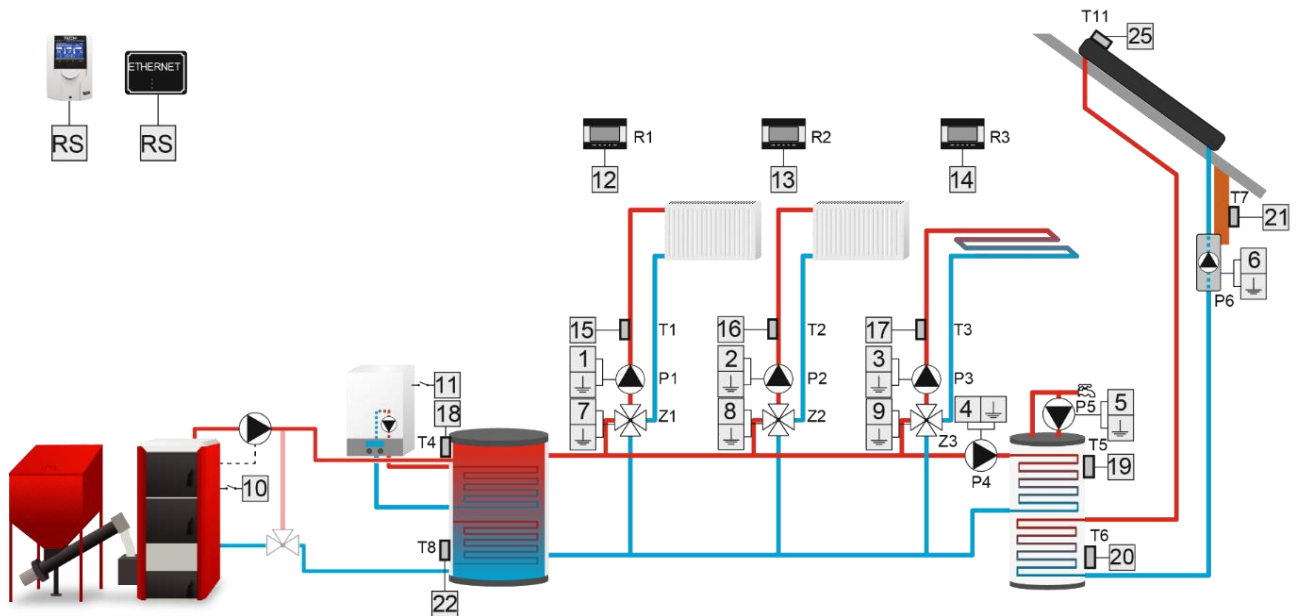

8. OPERATION CONTROL

The algorithm is based on the readings from one temperature sensor. The device connected to the additional contact will be used to control the operation of a different contact, DHW pump or room regulators. The device connected to the contact will be enabled when the controlled contact is switched on and the selected sensor fails to reach the pre-set temperature when the delay time is over. It will be disabled when the controlled contact switches off or when the selected sensor reaches the pre-set temperature. When the pre-set temperature is reached and the temperature drops again below the hysteresis, the device will be enabled after the time defined as *delay after error* is over.

- **Pre-set** – the user may define the pre-set temperature value for the selected sensor.
- **Hysteresis** - the user may set the temperature value below which the contact will be enabled, taking into account the pre-set temperature (Pre-set temperature-Hysteresis).
- **Delay** – the user may set the delay time after which the contact will be enabled.
- **Delay after error** - the user may set the delay time after which the contact will be enabled if the temperature drops again.
- **Sensor** - the user may select the sensor which will be used to control the contact operation.
- **Additional contact** - the user may select the device to be controlled - additional contact, DHW pump or room regulator.
- **Weekly control** - the user may define the time and days when the operation control function will be active.

Example:

Part of the heating system is handled by 2 CH boilers and a buffer. The task of the boilers is to heat the water in the buffer. Boiler is connected to voltage-free contact 2 with *operation control* function. The other boiler is connected to voltage-free contact 3 with *buffer* function. Buffer temperature is read by sensor T4 (CH). Additional contact supporting the boiler will be used to control the operation of the other boiler. If the controlled device does not get activated and the selected sensor fails to reach the pre-set temperature within the delay time, the controller will activate the device connected to the controlling contact.

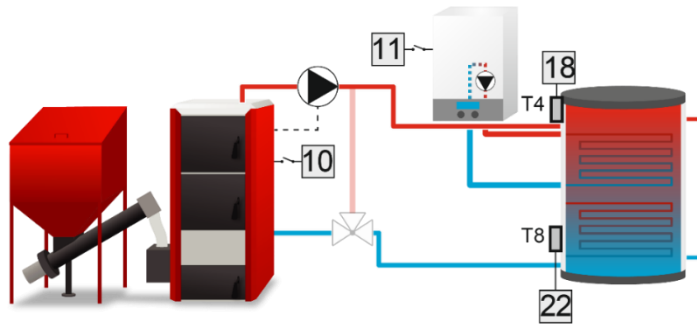

9. DHW

This algorithm is intended for controlling the operation of e.g. DHW pump. It is based on the readings from two sensors. The device connected to the additional contact will be enabled if the temperature measured by the source sensor is 2°C higher than the activation threshold and when the temperature drops below the pre-set value by the value of hysteresis. It will be disabled when the pre-set temperature of DHW sensor has been reached and if the source sensor hasn't reached the activation threshold.

- **Activation threshold** – the user may set the temperature value above which the contact will be enabled.
- **Hysteresis** – the user may set the temperature value below which the contact will be enabled, taking into account the pre-set temperature (Pre-set temperature+Hysteresis).
- **Pre-set DHW temperature** – the user may define the pre-set temperature.
- **Maximum temperature** – the user may define the maximum temperature for the source sensor. When this value is reached, the contact is enabled and it will remain active until the source temperature drops by 2 °C below the maximum temperature or the DHW sensor temperature exceeds the source temperature. This function protects the system against overheating.
- **Source sensor** – the user may select the sensor which will provide temperature readings for controlling the contact.
- **DHW sensor** - the user may select the sensor which will provide temperature readings for controlling the contact (pre-set temperature).

10. CONTROLLING THE ROOM REGULATOR

This algorithm is based on the signal from the room regulator. The device connected to the contact will be enabled when the regulator fails to reach the pre-set temperature (the regulator contact is closed). It will be disabled when the regulator reaches the pre-set temperature value (the regulator contact is open).

The device operation may also depend on the signal from more than one room regulator - it will be disabled only after all room regulators report that the pre-set room temperature has been reached. If DHW option is selected, the device connected to the additional contact will be enabled and disabled depending on the pre-set DHW temperature - when the pre-set temperature value has been reached, the device will be disabled.

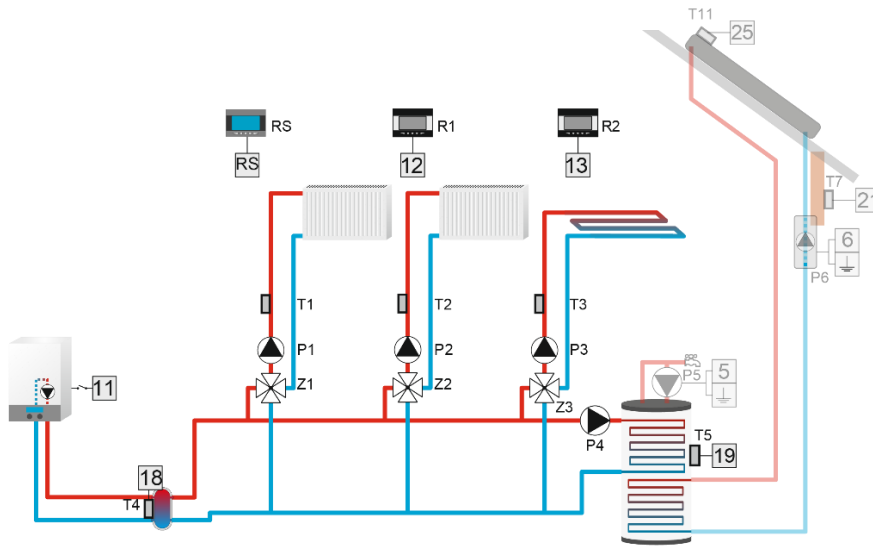

11. RELAYS

This algorithm is intended for controlling the device which will be activated together with the selected system devices. Enter *Operation modes* and configure the mode of contact activation:

- **All** - the contact will be enabled when all selected relays are active.
- **Any** - the contact will be enabled when any of the selected relays is active.
- **None** - the contact will be enabled if none of the selected relays is active.
- **Activation delay** – the pre-set time after which the contact will be enabled.
- **Deactivation delay** - the pre-set time after which the contact will be disabled.

12. WEEKLY CONTROL

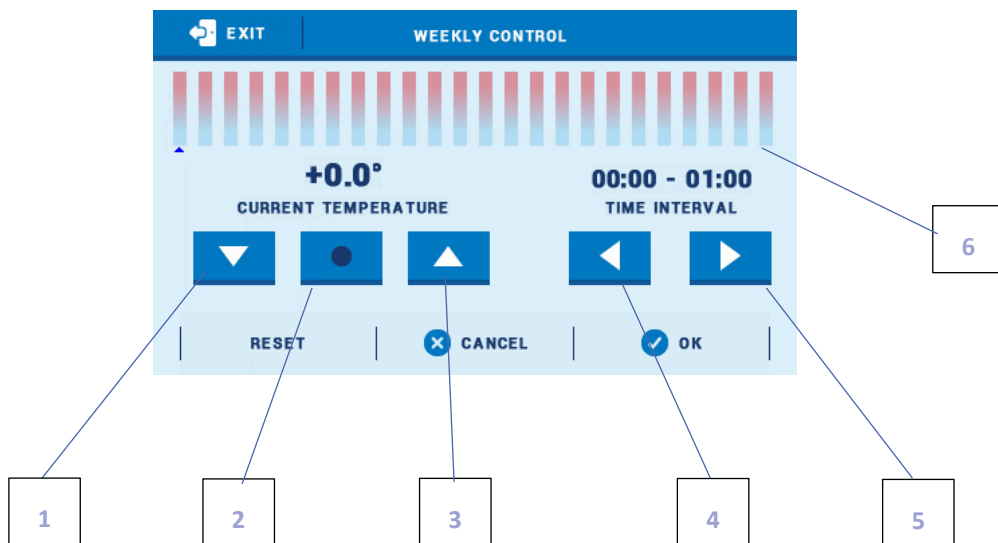

Weekly control algorithm enables the user to configure a schedule of contact activation. The user defines the days and time periods during which the device connected to the contact will be operating.



1. OFF
2. Copy the previous step
3. ON
4. Change the time period backwards
5. Change the time period forwards
6. Time period bar (24 hours)

Example:

In order to program valve closing for 09:00 - 13:00, follow these steps:

1. Select <OFF >
2. Use the icon  to set the time period: 09:00 - 09:30
3. Select <ON>
4. Use the icon  to copy the setting (the colour will change to red)
5. Use the icon  to set the time period: 12:30 - 13:00
6. Confirm by pressing <OK>

It is possible to copy the settings for selected days of the week:

- ✓ Select <Copy> (the top right-hand corner)

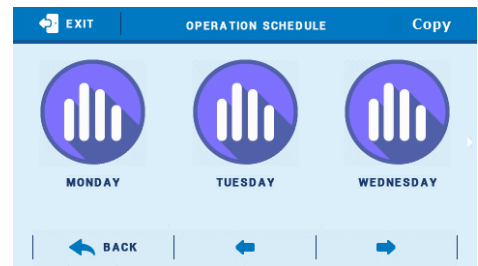

- ✓ Select the day to copy the settings from

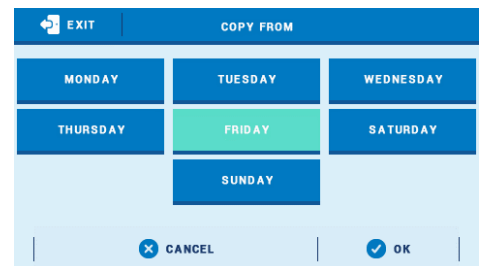

- ✓ Select day(s) to which the settings will be copied



13. MANUAL MODE

This option enables the user to enable/disable a given contact permanently.

14. OFF

This function enables the user to deactivate the additional contact altogether.

Part VI

Cascade

I. CASCADE

This algorithm is used to control the devices e.g. CH boilers using additional contacts. Depending on the mode selected, the boilers will be switched on one by one.

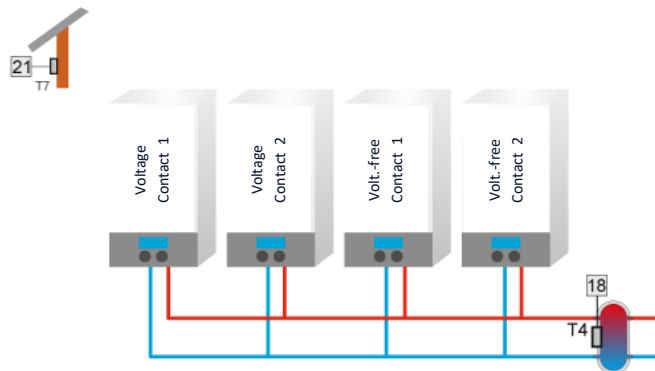

1. SELECT OPERATION ALGORITHM

- **Schedule** - In schedule mode, the contacts are enabled according to the pre-set order, which a qualified fitter may define in *Schedule modification* function. All contacts are activated after the pre-set *pause time*, when the need for activating a contact is reported. If the need to disable the contact is reported, the contact is deactivated after the pre-set *operation time*. If a change (enable/disable) is introduced during one of the two timers' operation, the countdown starts anew from the moment of introducing the change.

There are separate settings for DAY and NIGHT. They work in the same way. Operation time and pause time is separate for each contact. It is also different for day and night in the case of every contact.

It is possible to reset the motohours.

- **Motohours** - The order in which particular contacts are activated is determined by their operation time so far (motohours). The contacts with the smallest number of motohours will be activated first (current number of motohours is displayed in panel view). The contacts will be deactivated one by one, starting from the one with the largest number of motohours.

The operation time and pause time are the same for all contacts. When the need for activating the first contact is reported, the contact is enabled at once (Pre-set temp. - Hysteresis). The next contacts are activated after the pre-set *pause time*. When it is necessary to deactivate a contact, it happens after the pre-set *operation time*.

The only exception is when *main boiler* option is selected on the selected contact. Such a boiler will always be enabled as the first one and disabled as the last one. If the main boiler is active, the next boiler which will be activated after the need to activate the contact is reported, will be switched on after the pause time is over.

2. OPERATION MODE

- **Pre-set temperature** – the cascade will operate on the basis of the readings from the selected source sensor and the pre-set temperature.
Go to *Additional contacts* and select the additional contacts working in a cascade. Next, configure the pre-set temperature and hysteresis and select the source sensor. When the temperature measured by the source sensor drops (Pre-set temp. - Hysteresis), the first contact will be enabled (according to the selected operation algorithm). The contact will operate for the pre-set pause time. When the pause time is over, another contact will be enabled (according to the selected operation algorithm). Operation time works similarly to pause time. When the heat source temperature has been reached when the operation time is over, the contacts will be disabled one by one.
- **Heating need** – The algorithm is based on the readings from one temperature sensor.
The first contact selected in *Additional contacts* will be enabled when the temperature measured by the selected sensor drops below the highest pre-set temperature by the hysteresis of the selected circuits with a valve. It is also possible to select DHW circuit - the device will be enabled when the temperature drops by the value of DHW hysteresis. Within the range of pre-set temperature reduced by hysteresis (Pre-set temp. - Hysteresis) and the pre-set temperature next contacts will not be enabled - the contacts' operation will be maintained without activating next contacts. When the temperature drops below the pre-set value by hysteresis, the contacts are activated one by one, according to *pause time* parameter. When the source sensor exceeds the pre-set temperature by the value of *overheating*, the contacts will be disabled one by one, according to *operation time* parameter.
If all selected circuits report no heating need, all contacts will be disabled at once, regardless of the operation time.
- **Weather-based control** - This operation mode depends on the outside temperature.
The user defines temperature ranges and a corresponding number of boilers which will be enabled (Fitter's menu > Cascade > Weather-based control > CH boiler activation temperature 1-4).

3. ADDITIONAL CONTACTS

All contacts may operate in a cascade. This option enables the user to select particular contacts for a cascade.

4. SELECT SENSOR

The user may select the sensor which will provide temperature readings for the cascade.

5. MAIN BOILER

If *Main boiler* option is selected in a given contact (optional), in every operation mode this contact will be enabled as the first one and disabled as the last one. Only in *Heating need* mode, when all selected circuits report no heating need, all contacts will be disabled at the same time.

6. RESET MOTOHOURS

It is possible to reset the motohours for all contacts: Fitter's menu > Cascade > Reset motohours.

7. FACTORY SETTINGS

This function enables the user to restore factory settings of the cascade algorithm.

PART VII

Ethernet module

I. ETHERNET MODULE

Internet module is a device enabling the user remote control of the heating system. The user controls the status of all heating system devices on a computer screen, a tablet or a mobile phone.

Apart from the possibility to view the temperature of every sensor, the user can change the pre-set temperature of the pumps as well as the mixing valves. This module may also support additional contacts or a solar collector.

If a dedicated module ST-525 is connected, it is necessary to choose an appropriate WiFi network (and enter the password if necessary).

After switching the module on and selecting DHCP option, the controller automatically downloads such parameters as IP address, IP mask, Gateway address and DNS address from the local network. If any problems arise when downloading the network parameters, they may be set manually. The procedure of obtaining these parameters is described in detail in the instruction manual of the Internet module.

NOTE

This type of control is available only after purchasing and connecting an additional controlling module ST-505, ST-525 or WiFi RS, which is not included in the standard controller set.

PART VIII

Solar collector

I. SOLAR COLLECTOR

This option is used to configure the settings of solar collector and accumulation tank.

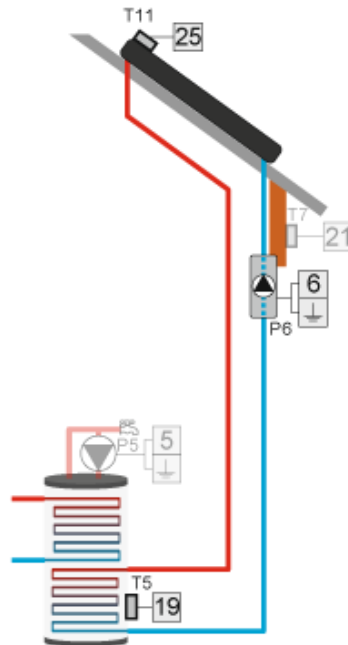

ON – Automatic control mode ON.

OFF – Automatic control mode OFF.

NOTE

ON/OFF option appears only after the contact has been selected.

NOTE

The contacts which have been selected in other algorithms will not be displayed in *Additional contact function*.

1. SOLAR COLLECTOR

- **Collector overheat temperature** - it is the acceptable alarm temperature of the solar collector at which the pump is forced to activate in order to cool down the solar panels. The discharge of warm water will take place regardless of the tank pre-set temperature. The pump will operate until the tank temperature drops below the alarm temperature by alarm hysteresis value (Fitter's menu > Solar collector > Solar collector > Alarm hysteresis).
- **Maximum collector temperature** - using this setting the user declares the maximum value of the collector alarm temperature at which the pump may be damaged. This temperature should be adjusted according to the collector technical specification.
- **Minimum heating temperature** - if the collector temperature is higher and starts to drop, the controller disables the pump when the minimum heating temperature is reached. When the collector temperature is below this

threshold and starts to increase, the pump is activated when the minimum heating temperature plus hysteresis (3°C) is reached. The threshold heating temperature is not active in the emergency mode, manual mode or collector defrosting.

- **Alarm hysteresis** - using this function the user sets the value of the collector alarm hysteresis. If the collector reaches the alarm temperature (Overheat temperature) and the pump is activated, it will be deactivated again when the collector temperature drops below the overheat temperature by the value of this hysteresis.
- **Anti-freeze temperature** - this parameter determines the minimum safe temperature at which glycol liquid does not freeze. In case of a significant drop in the collector temperature (to the value of *Anti-freeze temperature*), the pump is activated and operates continuously until the collector reaches safe temperature.
- **Defrosting time** - using this function the user determines for how long the pump will be activated once *Collector defrosting* function is selected.
- **Collector defrosting** - this function enables the user to activate the collector pump manually in order to cause the snow deposited on the solar panels to melt. Once this function is activated, the mode is active for a user-defined period of time. After this time automatic operation is resumed.

NOTE

Before activating the solar collector, make sure that PT-1000 sensor is connected to C4 sensor.

2. ACCUMULATION TANK

- **Pre-set temperature** – This option is used to define the pre-set tank temperature at which the collector pump will be disabled.
- **Maximum temperature** – This function is used to set the maximum safe temperature which the tank may reach in case of collector overheat.
- **Minimum temperature** – This function is used to set the minimum temperature which the tank may reach. Below this temperature the pump will not be enabled in collector defrosting mode.
- **Hysteresis** – If the tank reaches the pre-set temperature and the pump switches off, it will be enabled again after the tank temperature drops below the pre-set temperature by the hysteresis value.
- **Cooling to set temperature** – When the collector temperature is lower than the tank temperature, the pump is activated to cool the tank down.
- **Sensor selection** – This option is used to select the sensor which will send temperature data to the main controller. Return sensor is the default sensor.
- **Pre-set temp. of tank 2** – this function is used to define the pre-set temperature of tank 2. When this value has been reached, the valve switches to heat the tank with heating need to its pre-set temperature.
- **Maximum temp. of tank 2** – this parameter is used to define the maximum safe temperature value which tank 2 may reach in case of collector overheating.

- **Hysteresis of tank 2** – if tank 2 reaches the pre-set temperature and the pump is disabled, it will be enabled again when the temperature of tank 2 drops below the pre-set value by this hysteresis.
- **Sensor of tank 2** – this option enables the user to select the sensor which will provide the main controller with temperature readings. Additional sensor 2 is the default setting.
- **Valve hysteresis** – this setting concerns the control of a switching valve while cooling down the collector in summer mode or alarm mode or during defrosting. The valve hysteresis is the difference between the tanks' temperatures at which the valve switches to the other tank.

3. PUMP SETTINGS

- **Solar pump deactivation delta** – This function determines the difference between the collector temperature and the tank temperature at which the pump is deactivated in order not to cool down the tank.
- **Solar pump activation delta** – This function determines the difference between the collector temperature and the tank temperature at which the pump is activated.

4. ADDITIONAL CONTACT

This option is used to select the additional contact which will handle the solar collector pump. The user may only choose these contacts which have not been assigned other algorithm.

5. ADDITIONAL CONTACT 2

This option is used to select the additional contact for the valve switching between the two accumulation tanks. The collector circuit graphic on the installation screen will change to illustrate 2 accumulation tanks and a switching valve.

Part IX

Cooling

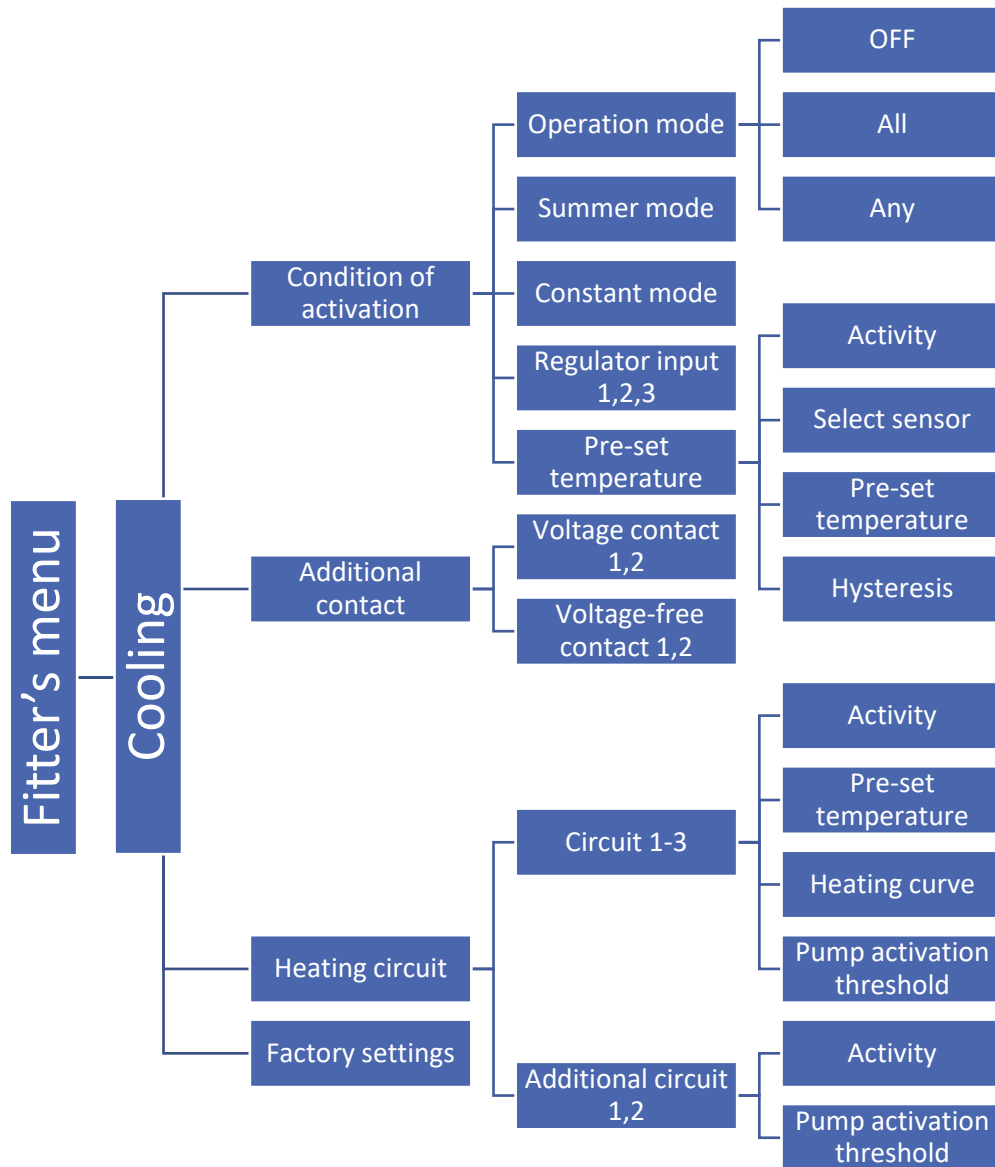

1. COOLING

Select this function to control the temperature of the cooling system (the valve opens when the pre-set temperature is lower than the temperature measured by the valve sensor).

NOTE

With this valve type, the following options do not work: CH boiler protection, return protection.

2. CONDITION OF ACTIVATION

In this submenu, the user selects the operation mode and defines the necessary condition which must be met to activate cooling in a particular circuit.

Example:

The selected condition is *Regulator 1 and 2 inputs* and the selected operation mode is *All*.

The condition which must be met to activate cooling is a signal from both regulator inputs. If the user selects *Any* as the operation mode, cooling is enabled when any of the inputs sends a signal.

3. ADDITIONAL CONTACT

During cooling, the selected additional contact is enabled.

4. HEATING CIRCUIT

This submenu enables the user to select the circuit which will operate in cooling mode. To ensure proper operation, configure activity and define the pre-set temperature for the circuit operation in the cooling mode. If the selected circuit operates according to *Weather-based control* function, the user may edit the heating curve for active cooling. Additionally, it is possible to set the temperature of pump activation.

Example:

If the pump activation temperature is set at 30°C, the circuit pump will operate below the pre-set temperature. When the temperature measured by the CH sensor is higher than 30°C, the pump will be disabled.

NOTE

If the CH sensor has been disabled, the pump operates all the time. The parameter selected in the valve menu (*Pump activation* → *Always OFF*) becomes deactivated and the circuit pump in cooling mode operates according to the parameter configured in *Cooling* → *Heating circuit* → *Circuit* → *Pump activation threshold*.

PART X

Sensor settings



I. SENSOR SETTINGS

- **External sensor calibration** – it is performed while mounting or after the regulator has been used for a long time, if the external temperature displayed differs from the actual temperature. Calibration range is from -10°C to +10°C.
- **CH sensor** – this option enables the user to set the threshold of CH sensor operation. If you select *Activity*, the sensor temperature which exceeds this threshold will activate an alarm. It is possible to configure the top and bottom temperature threshold. If the system does not include CH sensor, *Activity* should be deselected.
- **Additional sensors 1,2,3,4** – this option enables the user e.g. to set the sensor operation threshold. If 'Activity' has been selected, the sensor will activate an alarm when the temperature threshold has been exceeded. It is possible to set the top and bottom threshold of the sensor temperature. 'Sensor selection' option enables the user to select the type of sensor: KTY or PT1000.

NOTE

If the device controls a solar heating system, 'Additional sensor 4' will automatically be set as PT1000.

PART XI

Factory settings

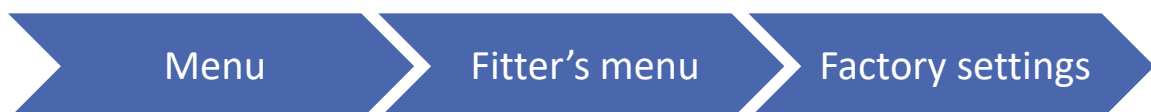

I. FACTORY SETTINGS

This function enables the user to return to the controller settings saved by the manufacturer.

NOTE

Restoring factory settings of the valves does not result in resetting all controller parameters.

PART XII

Settings



I. SETTINGS

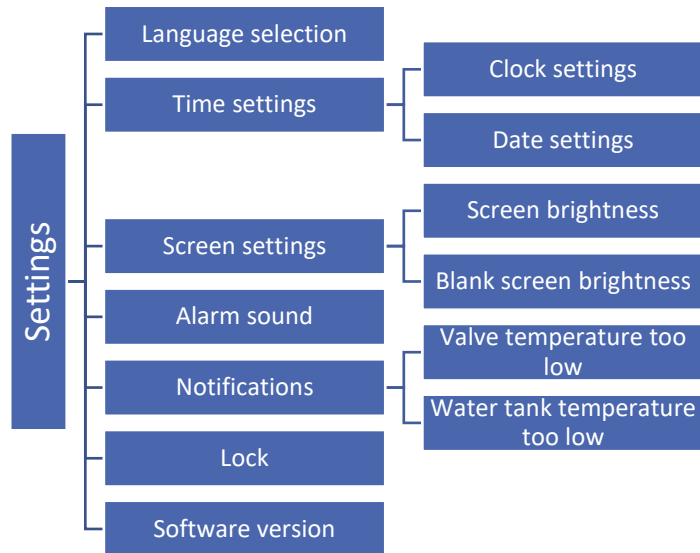

1. LANGUAGE SELECTION

This option is used to select the language version of the software.

2. TIME SETTINGS

This option is used to set the date and time displayed in the main screen.

To set these parameters, use the icons ▲ ▼ and confirm by pressing OK.

3. SCREEN SETTINGS

Screen brightness may be adjusted to individual user's needs. New settings are saved once the user exits the screen settings menu.

4. ALARM SOUNDS

This option is used to activate/deactivate an alarm sound informing about failure.

5. NOTIFICATIONS

This option enables the user to configure notifications informing that the valve or water tank temperature is too low.

6. LOCK

This function enables the user to lock access to the main menu. Follow these steps:

1. Select *Access code* option
2. Set your PIN code which will enable you to access the menu
3. Click OK to confirm.

NOTE

The default PIN code is 0000. If the PIN code has been changed by the user, 0000 will not work. If you forget the new PIN code, enter the following code: 3950.

7. SOFTWARE VERSION

When this option is selected, the display will show the manufacturer’s logo and the software version.

NOTE

The software version number is necessary while contacting the service staff.

PART XIII

Weekly control

I. WEEKLY CONTROL



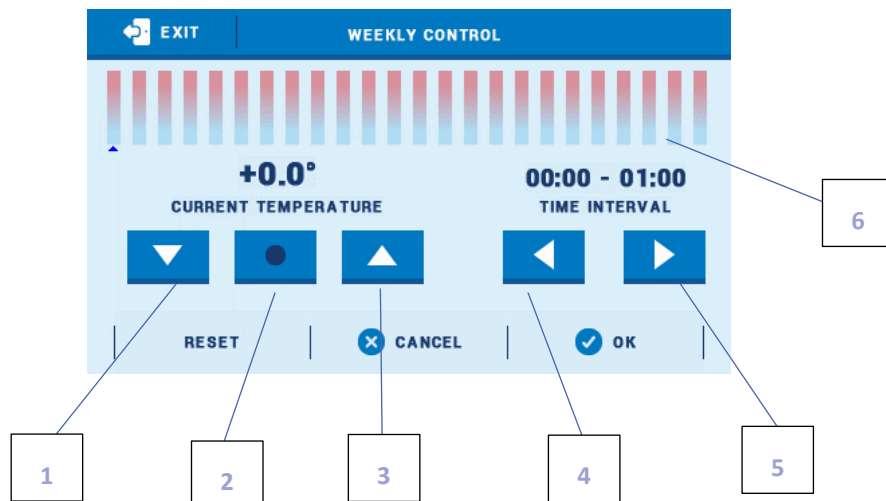



Weekly control function enables the user to program daily temperature changes. The pre-set temperature deviation range is +/- 20°C.



1. Decrease temperature deviation
2. Copy previous step
3. Increase temperature deviation
4. Change time period backwards
5. Change time period forwards
6. Time period bar (24 hours)

Example:

1. Set current time and date (Menu > Settings > Time settings > Clock settings/Date settings).
2. Select day of the week (Schedule modification) to program temperature deviation for certain hours. In order to program +5°C deviation for 06:00AM - 07:00AM and -5°C for 07:00AM- 3:00PM, follow these steps:

- Select  and set time period: 06:00AM - 07:00AM
- Select  and set temperature deviation: +5°C
- Select  and set time period: 07:00AM - 08:00AM
- Select  and set time deviation: -5°C
- Select  to copy the setting (the colour will change to red)
- Select  to set time period: 02:00PM – 03:00PM
- Press <OK> to confirm

3. It is possible to copy the settings for selected days of the week:

- ✓ Select <Copy> (top right-hand corner)

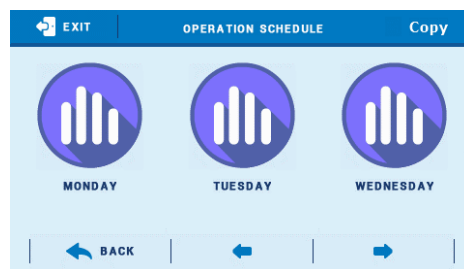

- ✓ Select the day to copy the settings from

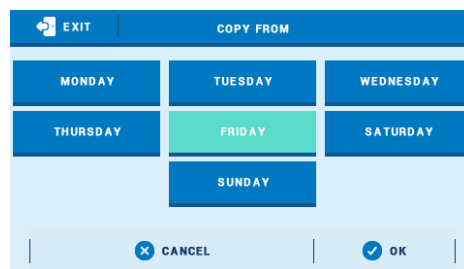

- ✓ Select day(s) to which the settings will be copied

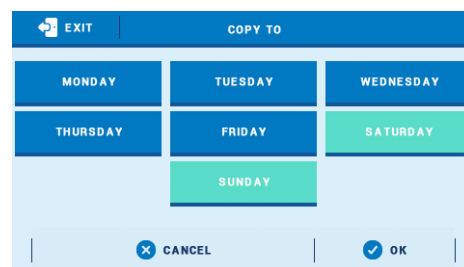

TECHNICAL DATA

Power supply	230V ± 10% / 50Hz
Max. power consumption	10W
Ambient temperature	5°C ÷ 50°C
Valve max. output load	0,5A
Pump max. output load	0,5A
Voltage contact max. output load	0,5A
Potential-free cont. nom. out. load	230V AC / 0,5A (AC1) * 24V DC / 0,5A (DC1) **
Sensor thermal resistance	-30°C ÷ 99°C
Fuse	6,3A

* AC1 load category: single-phase, resistive or slightly inductive AC load.

** DC1 load category: direct current, resistive or slightly inductive load.

PROTECTIONS AND ALARMS

In case of an alarm, a sound signal is activated, and the display shows an appropriate message.

Alarm	How to fix it
CH sensor damaged	<ul style="list-style-type: none"> - Check if the sensor has been installed properly. -If the cable has been extended, check the quality of the connection (soldered joints are recommended). - Check if the cable has not been damaged (especially the feeder sensor - it often gets melted). - Exchange the sensors (e.g. DHW sensor with the feeder sensor). In this way you can check if the sensors work properly. - Check the sensor resistance - Call the service
DHW sensor damaged	
Valve 1,2,3 sensor damaged	
Additional valve 1, 2 sensor damaged	
Return sensor damaged	
External temperature sensor damaged	
Return sensor of additional valve 1,2 damaged	
External sensor of additional valve 1,2 damaged	
Additional sensor 1, 2, 3, 4 damaged	

SOFTWARE UPDATE

In order to install new software, the controller must be unplugged from the power supply. Next, insert the flash drive with the new software into the USB port. Connect the controller to the power supply. A single sound means that the software update process has been initiated.

NOTE

Software update shall be conducted only by a qualified fitter. After the software has been updated, it is not possible to restore previous settings.

NOTE

After conducting the software update restart the controller.

USED SENSORS

KTY-81-210 -> 25°C – 2000 Ω

PT-1000 -> 0°C – 1000 Ω

*The pictures and diagrams are for illustration purposes only.
The manufacturer reserves the right to introduce some changes.*

TECH CONTROLLERS

EU DECLARATION OF CONFORMITY

Hereby, we declare under our sole responsibility that **EU-i-3** controller manufactured by TECH Sterowniki II Sp. z o.o., head-quartered in Wieprz Biała Droga 31, 34-122 Wieprz, is compliant with Directive 2014/35/EU of the European Parliament and of the Council of 26 February 2014 on the harmonisation of the laws of Member States relating to the making available on the market of electrical equipment designed for use within certain voltage limits (EU OJ L 96, of 29.03.2014, p. 357), Directive 2014/30/EU of the European Parliament and of the Council of 26 February 2014 on the harmonisation of the laws of Member States relating to electromagnetic compatibility (EU OJ L 96 of 29.03.2014, p.79), Directive 2009/125/EC establishing a framework for the setting of ecodesign requirements for energy-related products as well as the regulation by the Ministry of Entrepreneurship and Technology of 24 June 2019 amending the regulation concerning the essential requirements as regards the restriction of the use of certain hazardous substances in electrical and electronic equipment, implementing provisions of Directive (EU) 2017/2102 of the European Parliament and of the Council of 15 November 2017 amending Directive 2011/65/EU on the restriction of the use of certain hazardous substances in electrical and electronic equipment (OJ L 305, 21.11.2017, p. 8).

For compliance assessment, harmonized standards were used:

PN-EN IEC 60730-2-9:2019-06,

PN-EN 60730-1:2016-10,

EN IEC 63000:2018 RoHS.

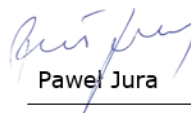
Paweł Jura

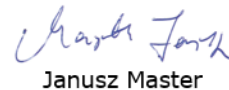
Janusz Master

Prezesa firmy

Wieprz, 04.12.2023

**TECH
TECH
CONTROLLERS**

Central headquarters:

ul. Biała Droga 31, 34-122 Wieprz

Service:

ul. Skotnica 120, 32-652 Bulowice

phone: **+48 33 875 93 80**

e-mail: **serwis@techsterowniki.pl**

www.tech-controllers.com